



Rutherford

Marine

A MEMBER OF THE *Hudaco* GROUP



**PRODUCT
CATALOGUE**

2022/2023

INDEX

22A Quicksilver Parts & Accessories	Page: 1	
22A Props	Page: 15	
22S Spark Plugs	Page: 29	
23 Power Accessories	Page: 63	
24 Hydraulic Steering	Page: 75	
25 Control Boxes & Cables	Page: 83	
25S Mechanical Steering	Page: 89	
27 Instrumentation	Page: 93	
28 Steering Wheels	Page: 103	
29 Trolling Motors	Page: 107	
30 Lubricants & Performance Products	Page: 113	
37 Boat Accessories	Page: 117	
39 Trailer Accessories	Page: 141	
40 Lights, Switches & Batteries	Page: 143	
41 Navigation	Page: 155	
42 Safety Equipment	Page: 159	
44 Plumbing & Galley	Page: 163	
46 Boat Hardware	Page: 169	
47 Order Form	Page: 176	
48 Anchors	Page: 177	
50 Watersport	Page: 179	

Rutherford

Marine

A MEMBER OF THE *Hudaco* GROUP

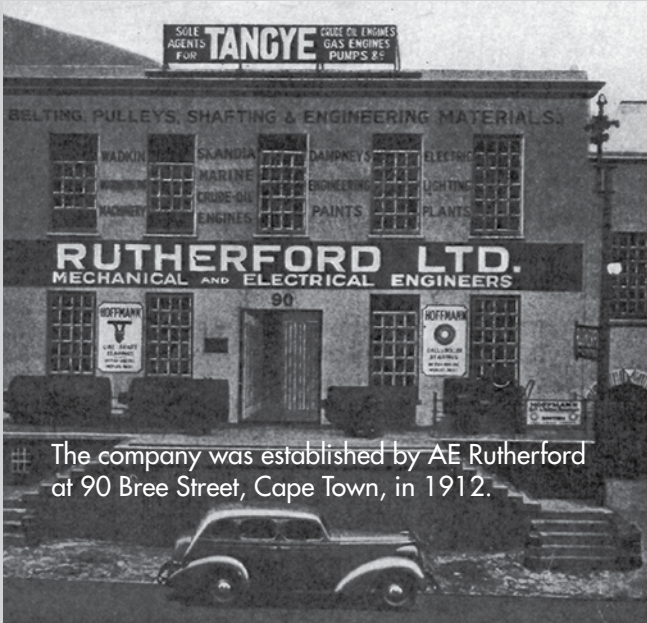

The company was established by AE Rutherford at 90 Bree Street, Cape Town, in 1912.

MARINE SUPPLY

Everything You Need To Boat!

With a wide range of marine supplies to inspire you, our marine portfolio has everything you need to start boating.

Leaders in marine supply since 1912, Rutherford Marine continues to serve as a primary source of marine product and ensures that we offer a comprehensive range to meet the demands and standards of the modern marine industry.

EFFICIENT PROCESSES

Our Delivery To You

Most of the marine products showcased in this catalogue are stocked in our own warehousing facilities around the country.

The main depot – the largest of its kind in South Africa, is based in Germiston - Gauteng. Our modern logistics and delivery network will ensure that your marine order is delivered ex-stock where you need it and when you need it.

OUR PROMISE TO YOU:

Great Products. Superb Quality. Outstanding Service

When you fill your retail stores and or finish your boats with our products, you do so with style and confidence. Our quality products are backed by industry leading warranties and all our products adhere to international quality and safety standards and also to stringent South African requirements.

Our competitive product pricing will ensure you as a dealer, ample profit opportunity for your retail store.

IT'S BRANDED

In One Sense, Perhaps The Most Important Sense, A Brand Is A Promise

Rutherford Marine only stocks and supplies branded products suited for application in the marine industry, sourced directly from manufactures all over the world.

We are proudly associated with the top brands the industry has to offer.

SERVICES

- Regional sales offices
- A knowledgeable sales force
- Product quality guaranteed
- Massive product range
- Extensive stock holding
- National delivery
- Local and International product sourcing
- Product Technical support team
- Product technical training

PAYMENT

- We accept:
- All major credit cards
 - EFT/ Internet payments
 - Cash
 - A 30 day account facility (subject to successful credit approval)

WARRANTY

Rutherford Marine warrants all goods in this catalogue for a period as stated per manufacturer's conditions.

Our simple and speedy warranty procedure will ensure your customer satisfaction

HOW TO CONTACT US



JHB - 011 878-2600
CPT - 021 932-0568



marine@rutherford.co.za



www.rutherfordmarine.co.za



Rutherford Marine
South Africa



Be aware of pirates parts!

QUICKSILVER

Marine Parts & Accessories

Pay attention to your engine safety!

Use only Quicksilver parts and accessories, because only Quicksilver grant you reliability and full efficiency... this is the original parts strength!

The materials employed are exclusively developed for Mercury and MerCruiser engines. Our lubricants, accessories, spare parts and propellers are the right choice for each engine.



PARTS & ACCESSORIES

Transom Bolt Kit Stainless Steel

A1



Part No.

- 10-67755A22 - 2.50" 10-67755A15 - 6.5"
- 10-67755A26 - 3.5" 10-67755A17 - 7.5"
- 10-67755A13 - 4.5" 10-67755A18 - 8.00"
- 10-67755A14 - 5.5"

Prop Nut 60 BF through V6 & MCM Alpha

A2



Part No.

11-52707Q1

Prop Nut Kit 30 through 60HP STD Gearcase

A3



Part No.

11-69578Q1

Washer Non Flow Torq Hub V6 & Alpha applications

A4



Part No.

12-31211Q03

Thrust Washer 60BF Through V6 & MCM Alpha Applications

A5



Part No.

12-835467Q01

Exhaust Outlet Flapper Kit 3"

A6



Part No.

34765Q02

Exhaust Outlet Flapper Kit 4"

A7



Part No.

12644A1

Trim Limit Spacer Kit MCM

A8



Part No.

15768A3

Lazer Vent Slot Plug Kit R/H V6P B1



Part No.
19220A4

Hose Kit - Rigging B2



Part No.
32-825191A03- Std
32-8M0062693- 150Hp 4 stroke only
32-8M0088822- 75 - 115Hp 4 stroke tiger shark

Tubing - 100FT B3



Part No.
32-859785100- Bulk water pressure tubing

Rigging Tube Kit B4



Part No.
32-842756T01- 3L EFI and Optimax V6

Fuel Line 100FT B5



Part No.
32-8M0038500- 8mm Inside diameter
32-8M0038563- 10mm Inside diameter

100FT Oil Fill Hose B6



Part No.
32-850719

Fuel Filter * B7



Part No.
35-816296A3 - 8 thru 15 Fourstroke
35-816296Q03 - In Line Fuel Filter 1/4" I/D 8-15Hp 4/S
35-816296Q2 - In Line Fuel Filter 5/16 I/D
35-898101093 - 25-30 EFI 4 Stroke
35-8M0057677 - 150 Fourstroke
35-8M0060041 - 3L Optimax
35-879885Q - In Line Filter thru Verado 4/S 75 ESI

Element Fuel Filter Verado B8



Part No.
35-886638 - 200Hp thru 300Hp 6 cyl Verado

Oil Filter

C1



Part No.

35-822626T7 - 225HP - V6 fourstroke
 35-858004Q - V8 Mercruiser High Efficiency
 35-866340Q03 - MCM and MIE V8 GM model
 35-877761Q01 - 275 thru 115 1700cc 4/S & 50 4/S ER
 35-877767Q01 - 135 thru 200 four cylinder Verado
 35-883702Q - V6 Mercruiser

Oil Filter (Ford V8)

C2



Part No.

35-802886Q

Oil Filter Assembly

C3



Part No.

35-822626Q03 - 8 thru 30HP 2006 & newer
 35-8M0005103 - 75-115 fourstroke

4-Stroke Oil Filter

C4



Part No.

35-877769Q01 - 200Hp thru 400Hp 6 cyl Verado

Oil Warning Kit -Visual

C5



Part No.

17334A7 - V6

Analog Water Pressure Kit

C6



Part No.

32-8M0063663

Water Separated Fuel Filter Kit

C7



Part No.

35-886638A01
 35-8M0114618 - 6 cyl gen IV + newer Verado

Stabiliser Clips

C8



Part No.

64-891762A04 - Outboards Trailing

Trim Tab

D1



Part No.

31640Q4 - 45Hp & Up - Salt water Std
31640T07 - 45Hp & Up not anode

Element

D2



Part No.

881540 - 75 thru 115 4/Stroke

Battery Cable 6FT

D3



Part No.

45107 - (+)
45108 - (-)

Foot Throttle

D4



Part No.

64-892764A01 - Bottom Load Cable

Hot Foot Throttle Top Load

D5



Part No.

64-892764A02 - Pro Top Load

Mount - Slide (Hot Foot)

D6



Part No.

64-892764A03

Outboard Lock

D7



Part No.

67-808912 - 40Hp larger Mercury
67-808913 - 50Hp larger Yamaha
67-808914 - 40Hp larger Evinrude

Rope and Handle (Emergency Start)

D8



Part No.

47341A11

Switch Kit-Short

E1



Part No.
F5H268

Switch Kit-Long

E2



Part No.
F5H078

H/D Battery Cables

E3



Part No.
84-61378A2

Battery Gauge Tester

E4



Part No.
67-892763A17

Trim Sensor Kit - Alpha - Bravo

E5



Part No.
805320A03

60-125Hp Bleaching Kit

E6



Part No.
810776A1BK

Lanyard

E7



Part No.
15920Q54

Lanyard Assembly

E8



Part No.
823054Q - Mariner / Yamaha

Switch / Lanyard Kit-Ob

F1



Part No.
87-19674A08 - Single engine

Lanyard Stop Switch

F2



Part No.
87-814324A2 - Dual Engine

Yamaha / Mariner 25C Lanyard

F3



Part No.
97756M

Trim Tab 40, 55, 60 (83859M) Mariner / Yamaha

F4



Part No.
83859T

Trim Tab Anode 20, 25C, 28, 30A - Mariner

F5



Part No.
82795T

Trim Sender Kit

F6



Part No.
891777A01 - Digital
8M0074845 - Analogue White
8M0074846- Analogue Black

Trim Sensor Assembly

F7



Part No.
8M0052523- 150 4/Stroke

H/Ware Kit

F8



Part No.
86-813937A2

Anode Assembly Kit (*)

G1



Part No.		
42121Q02	821630A2	865182Q01
76214Q5	821630Q1	888756Q03
806189Q1	821631Q1	888758Q02
806190Q1	823913Q	888760Q03
818298Q1	826134Q	888760Q04
818298T3	856581C	888761Q03
821629Q1	89189Q1	888761Q04

Anode Kit

G2



Part No.
809189Q1
888760Q03
888956Q04

Beaching Springs V6 Kit

G3



Part No.
878406A1BK

Link Rod Kit

G4



Part No.
92876A10

Skeg 4/Stroke

G5



Part No.
8M0060147 - Mercury 150Hp EFI & 75 thru 115 Tiger shark

Skeg Replacement

G6

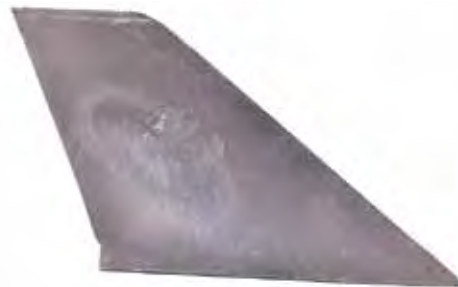

Part No.
15985A02 - 60Hp BF thru 125Hp
815632A02 - MCM Bravo 1 and 3
859447A1 - V6, 4cyl and 6cyl outboards
898245A01 - Verado 135Hp - 300Hp and 3L

Battery Isolator - 95

G7



Part No.
8M6001343

Flush Attachment

G8



Part No.
843122T01 - For use Bravo 1 Sports Master
848998191 - For Mercury Racing Sports Master

Flushing Kit

H1



Part No.
881150Q1 - Dual water pick up Seal Kit

Coupler-Fuel Line (F197787-3)

H2



Part No.
F197787Q3

Reflex Hub Kit

H3



Part No.
835257Q12

Flo Torq III Kit

H4



Part No.
8352571Q12

Part No.
835258Q2

Harnes Only Tacho

H5



Part No.
84-86396A8 -2/Stroke 8 pin

14 Pin Analogue Harness

H6



Part No.
84-86398A8 - 2006 Newer EFI & Optimax

Mercathode Kit

H7



Part No.
88334A2 - All boat applications 12V

Hub Kit (Rubber)

H8



Part No.
43676T - 13 Spline 30Hp - 60Hp non BF

Thrust Washer

11

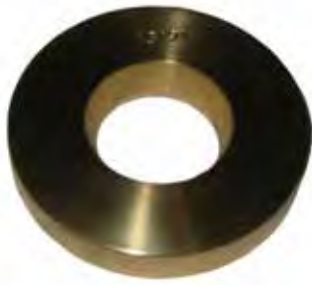

Part No.
13191Q01 - BF thru 125Hp

Prop Nut Kit

12



Part No.
13914Q02 - Merc/Mariner 6Hp - 15Hp

Tab Washer

13



Part No.
14-76281Q

Lube / Grease Gun

14



Part No.
91-30500Q5

Lube Gun Pistol Lube

15



Part No.
91-37299Q2

Lube Pump 10L

16



Part No.
91-850730Q1

Gear Lube Pump Adaptor

17

Adapts our quart, Litre and 2-1/2 gallon gear lube pumps for filling the gearcase. Fits outboards of Japanese origin i.e. Yamaha, with an 8 x 1.25 metric threaded gear lube fill hole.



Part No.
91-883704Q03

Salt Flush 1 Litre

18



Part No.
A92- SALT -1Litre
A92-20-01-079 - Flush Attachment

H.P. 1L Pump and Lube

J1



Part No.
91-8M0050053

Pump Gear Lube

J2



Part No.
91-8M0072133 - 1 litre

Sealer

J3



Part No.
92-34227Q02

Coolant

J4



Part No.
92-8M0056173

Assembly Grease 16oz

J5



Part No.
92-8M0071836

High Performance EXTREME Grease

J6



Part No.
92-8M0071837 - 3 oz
92-8M0071838 - 8 oz

Quickare Fuel Treatment

J7



Part No.
92-8M0079743 - 355ml
92-8M0058680 - 946ml

Quickleen Engine Fuel System Cleaner

J8

Quickly and thoroughly remove carbon deposits from carburetors and injectors, Intake valves, spark plugs, piston crowns and cylinder heads. Prevent engine knocking and piston seize-up. Extend spark plug life.



Part No.
92-8M0079744 - 355ml
92-8M0058681 - 946ml

Quickstor - Fuel Stabiliser

K1

Prevent regular and ethanol blended fuel from breaking down and oxidizing. Keep fuel fresh for up to a year. Prevent fuel system corrosion.

Prevent gum and varnish from forming in the fuel and settling in fuel lines and tanks, carburettors and injectors. Keep injectors and carburettors lubricated.



Part No.

92-8M0079745 - 355ml
92-8M0058682 - 946ml

Synthetic Power Steering Fluid

K2



Part No.

92-858076K01 - 236ml
92-858077K01 - 946ml

Neoprene - 1/2pt

K3



Part No.

92-257113

Power Steering Fluid

K4



Part No.

92-858074QB1 - 240ml
92-858075Q01 - 946ml

Hydraulic Steering Fluid

K5



Part No.

92-858078QB1 - 1L

2-4-C Marine Lube with Teflon

K6

Used to lubricate steering systems, cable linkages and remote controls, grease fittings, prop shafts and swivel pins.



Part No.

92-802859Q1 - 227gm Tube
92-802863Q1 - 397gm

Lube - 3 Cartridge

K7

Refill Cartridges 3 x 99g



Part No.

92-802861Q1

Cartridge Gun with Cartridge

K8



Part No.

91-74057Q5

Anti Corrosion Grease

L1

Do not use on ball, roller or needle bearings.



Part No.
92-802867Q1

Needle Bearing Lube

L2

For assembly of internal engine parts.



Part No.
92802868Q1

Lube - 14oz

L3



Part No.
92-802870Q1

Corrosion Guard

L4

Use Corrosion Guard to spray on motor power heads, electrical connections and external components to prevent against anti oxidants through air pollution.



Part No.
92-802878Q55

Degreaser

L5

Removes grease, oil, lubrication fluids, metal cuttings, and filings from parts equipment and machinery. Recommended for final assembly cleaning treatment for all surfaces bonded with adhesives. 444ML Spray Can.



Part No.
92-8M0086226 - 1 Litre
92-8M0086227 - 4 Litre

Paint

L6

Part No.

- 92-802878Q1 - Black
- 92-802878Q10 - Grey
- 92-802878Q12 - Silver
- 92-802878Q14 - Light Grey
- 92-802878Q16 - Grey (Pre 1984)
- 92-802878Q2 - 6 Black
- 92-802878Q20 - V Silver
- 92-802878Q50 - Prop Paint Black
- 92-802878Q52 - Primer Paint
- 92-802878Q54 - Paint Leveler



Silicon Dielectric Compound

L7

Protects and displaces moisture from spark plug boots, coils, and other electric components. 227 gm tube.



Part No.
92-8235061

High Performance Lube

L8

Specifically formulated for performance outboards, inboards and 3L Mercury and Mariner outboard motors.



Part No.
92-858064QB1 - 1 Litre
92-802851Q02 - 237ml
92-858068-5L - 5 Litre
92-858065QB1 - 10 Litre
92-858068QB1 - 208 Litre Drum

Gear Lubes - Premium

M1



Part No.

92-19007-5L - Sold as 5L
 92-802844Q02 - 8oz
 92-858058QB1 - 1L
 92-858059QB1 - 9.4L
 92-858062QB1 - 208L Drum

Cleaner - Engine / Power Tune

M2



Part No.

92-858080Q03

Storage Seal

M3

Storage Seal prevents rust from forming in your engine while the boat is in storage.

To use remove the spark plugs and inject spray 5 second spray into each cylinder, rotate the flywheel manually and spray each cylinder while piston is at the bottom of the cylinder. 355ml spray can.



Part No.

92-858081Q03

Compound Finish

M4



Part No.

92-859026K1



PROPELLERS

Chopper Prop 30 Thru 60 Hp Standard

A1

**Part No.**

48-43592A71 - 10 3/8 x 18"

V6 Chopper Prop

A2

**Part No.**

48-13370A62 - 14.5 x 26"

48-13372A62 - 14.5 x 28"

48-13368A62 - 14.5 x 24"

Spitfire Prop

A3

Part No.

48-8M8026630 -

10.1 x 13" - 30 Thru 60 Standard

48-8M8026635 -

10.1 x 14" - 30 Thru 60 Standard

48-8M8026640 -

10.1 x 15" - 30 Thru 60 Standard

48-8M8026625 - 10.6 x 12" - 30 Thru 60 Standard

48-8M8026600 - 12.5 x 19" - 60 BF Thru 125

48-8M8026555 - 13.8 x 10" - 60 BF Thru 125

48-8M8026560 - 13.8 x 11" - 60 BF Thru 125

48-8M8026570 - 13.8 x 13" - 60 BF Thru 125

48-8M8026580 - 13.4 x 15" - 60 BF Thru 125

48-8M8026590 - 13.0 x 17" - 60 BF Thru 125

48-8M008494 - 14 x 17 RH - V6 and MCM

48-8M008495 - 14 x 19 RH - V6 and MCM

48-8M008496 - 12 x 21 RH - V6 and MCM

48-8M008497 - 14 x 23 RH - V6 and MCM

**Bravo 1 Prop V6 and Verado**

A4

Part No.

48-831910A45 -

15 1/4 x 22" R.H.

48-831912A45 -

15 1/4 x 24" R.H.

48-831914A45 -

15 1/4 x 26" R.H.

48-831912A65 -

15 1/4 x 26" H.D.

48-831916A65 -

15 1/4 x 28" H.D.

48-831912L65 -

15.25 x 24" R.H. LAB Finish

48-831914L66 - 15.25 x 25" R.H. LAB Finish

48-831916L66 - 15.25 x 28" R.H. LAB Finish

48-831918A55 - 15 1/4 x 30" R.H. Solid Hub

**Bravo 3 Prop MCM**

A5

**Part No.**

48-8M8022340 - 16 x 19" L.H.

48-8M8022350 - 14.4 x 19" R.H.

48-823665A60 - 15.5 x 24" L.H.

48-823666A60 - 14.25 x 24" R.H.

48-823668A60 - 14 x 26" R.H.

48-823667A60 - 15.25 x 26" L.H.

48-8M8022360 - 116 x 20 LH Front

48-8M8022370 - 14.4 x 20 RH Rear

60BF-125 HP Lazer Prop

A6

**Part No.**

48-899004A46 - 13.25 x 19"

48-899006A46 - 13.25 x 21"

48-16996A46 - 13.5 x 26" S/S

V6 S/S Mirage Prop

A7

**Part No.**

48-19838A46 - 15.75 x 15" RH

48-19841A46 - 15.75 x 15" LH

48-826072A46 - 16 x 13" R.H.

48-90159A46 - 17"

48-18278A46 - 17" R.H.

48-13700A46 - 19"

48-13701A46 - 19" L.H.

48-13702A46 - 21"

Fury Prop

A8

**Part No.**

48-8M8023120 - 14 x 24" R.H.

48-8M8023140 - 14 x 25" R.H.

48-8M8023160 - 14 x 26" R.H.

Enerzia Prop B1

Part No.
 48-898990A46 - 15 x 15 RH
 48-898991A46 - 15 x 15 LH
 48-898994A46 - 14.50 x 17 RH
 48-898995A46 - 14.55 x 17 LH
 48-898998A46 - 14.375 x 19 RH
 48-898999A46 - 14.375 x 19 LH
 48-899002A46 - 14.125 x 21 RH
 48-899202A46 - 13.5 x 22 RH
 48-8M0070074 - 15.6 x 12 RH
 48-8M0070076 - 15.6 x 12 LH
 48-8M0070079 - 16 x 11 RH
 48-8M0070077 - 16 x 11 LH
 48-8M0079504 - 15.1 x 14
 48-8M8023140 - 14 x 25 RH
 48-8M8023160 - 14 x 26 RH
 48-8M8023180 - 14 x 27 RH



Pro Max Prop B2

Part No.
 48-8M0079698 - 14.5 x 23"
 48-8M0079699 - 14.5 x 24"
 48-8M0079700 - 14.5 x 25"
 48-8M0079701 - 14.5 x 26"
 48-8M0079702 - 14.5 x 27"
 48-8M0079703 - 14.5 x 28"
 48-8M0079704 - 14.5 x 29"



Black Max Prop B3

Part No.
 48-815083A02 - 7.38 x 7" - 2.5 to 3.5 HP
 48-815083A01 - 7.4 x 6" - 2.5 to 3.5 HP



Black Max V6 & MCM Aluminium Prop B4

Part No.
 48-832834A45 - 13.5 x 23"
 48-832830A45 - 14 x 19"
 48-832832A45 - 14.25 x 21"
 48-78116A45 - 15.5 x 15"
 48-78112A45 - 16 x 11"
 48-78114A45 - 16 x 13" W/BOAT
 48-16440A45 - 16 x 16
 48-832828A45 - 14" x 17"



Black Max 6 - 15 HP Standard Aluminium Prop B5

Part No.
 48-828152A12 - 9.25 x 7"
 48-828156A12 - 9 x 9"
 48-828150A12 - 9.75 x 6" (High Reverse)
 Black Max 30 - 60 HP Aluminium Prop



Black Max 25 HP Aluminium Prop B6

Part No.
 48-19636A10 - 10 3/8 x 9 1/2"
 48-19638A40 - 10 3/8 x 11"
 48-19639A40 - 10 3/8 x 12"
 48-19640A40 - 10 3/8 x 13"



Black Max 30 - 6 HP Aluminium Prop B7

Part No.
 48-85632A45 - 10.88 x 11" R.H.
 48-816702A45 - 10.75 x 12"
 48-73134A45 - 10.62 x 12"
 48-73136A45 - 10.38 x 13"
 48-816704A45 - 10.5 x 13"
 48-73138A45 - 10.25 x 14"
 48-816706A45 - 10.38 x 14"
 48-73140A45 - 10.12 x 15"
 48-73144A45 - 10 x 17"
 48-73132A45 - 11.25 x 10"
 48-87818A11 - 12.25 x 9"
 48-87818A45 - 12.25 x 9"
 48-42740A45 - 12 x 10.5"
 48-854340A33 - 14 x 9" R.H.



Black Max 60BF - 125 HP Aluminium Prop B8

Part No.
 48-77348A45 - 12.75 x 21"
 48-854352A45 - 13.88 x 14" R.H.
 48-77342A45 - 13.75 x 15"
 48-854354A46 - 13.25 x 15" R.H.
 48-854360A45 - 13 1/4 x 16"
 48-77344A45 - 13.25 x 17"
 48-77346A45 - 13 x 19"
 48-854342A45 - 14.00 x 10" R.H.
 48-77338A45 - 14 x 11"
 48-77340A45 - 14 x 13"



Black Max Prop 9.9 Thru 20 HP Fourstroke C1



Part No.
48-812949A02 - 7.8 x 7P

Black Max Prop 25 Thru 30 HP Fourstroke C2



Part No.
48-896890A10 - 10 x 8"
48-896896A40 - 9.5 x 11P

Black Max II Spine Aluminium Prop C3



Part No.
48-3774A1 - 10.75 x 10"

Alpha 4 V6 Aluminium Prop C4



Part No.
48-834853A45 - 14.5 x 18" L.H.
48-834852A45 - 14.5 x 18" R.H.
48-834851A45 - 15 x 16 L.H.
48-834850A45 - 15 x 16 R.H.
48-83485A45 - 20" 4-BLADE L.H.
48-834845A45 - 20" 4-BLADE R.H.

Vengeance Prop 30 - 60 HP Standard C5



Part No.
48-855860A5 - 10.38 x 14" S/S
48-855862A46 - 10.25 x 15" R.H.
48-85586A5 - 11 x 12" R.H.

V6 S/S Vengeance Prop C6



Part No.
48-16318A46 - 13 3/4 R.H. 21
48-16319A46 - 13 3/4 L.H. 21
48-16320A46 - 13 1/2 R.H. 23
48-16321A46 - 13 1/2 L.H. 23
48-16312A46 - 14.5 x 15" R.H.
48-16314A46 - 14.5 x 17" R.H.
48-16315A46 - 14.5 x 17" L.H.
48-16316A46 - 14 x 19" R.H.
48-16317A46 - 14 x 19" L.H.
48-16319A4 - 14 x 21"

60BF-125 HP S/S Vengeance Prop C7



Part No.
48-17312A46 - 12"
48-17314A46 - 14"
48-16986A46 - 16"
48-16988A46 - 18"

Revolution 4 Prop C8



Part No.
48-857022A46 - 14.62 x 15"
48-857024A46 - 14 5/8 x 17"
48-857025A46 - 14 5/8 x 17"
48-857026A46 - 14 5/8 x 19"
48-857027A46 - 14 5/8 x 19"
48-857029A46 - 14 5/8 x 21" 4 Blade S/S L.H.
48-857028A46 - 14 5/8 x 21" 4 Blade S/S R.H.
48-857028A46 - 14 5/8 x 21" 4 Blade S/S R.H.
48-857030A46 - 14 5/8 x 23" R.H.
48-857032A46 - 14.62 x 25" R.H.

Vensura Prop D1



Part No.
 48-825903A48 - 4 BLADE 14" L.H.
 48-825899A48 - 4 BLADE 17" L.H.
 48-825898A48 - 14 1/2 x 17" R.H.
 48-825901A48 - 4 BLADE 19"
 48-825900A48 - 14 x 19" R.H.
 48-825902A48 - 4 BLADE 21" R.H.
 48-825906A48 - 14 x 23" R.H.
 48-825907A48 - 14 x 23" L.H.

Trophy Prop D2



Part No.
 48-825932A46 - 13.75 x 19"
 48-825930A46 - 13 3/4 x 17"
 48-825934A47 - 13 3/4 x 21"
 48-825938A47 - 13.75 x 23" R.H.
 48-825940A48 - 13.75 x 24"
 48-825942A47 - 13.75 x 25"
 48-825944A47 - 13.75 x 26" R.H.
 48-825946A47 - 13 3/4 x 27"
 48-825948A47 - 13 3/4 x 28"

Fury 4 Blade D3



Part No.
 48-8M0114407 - 14.5 x 23"
 48-8M0114408 - 14.5 x 24"
 48-8M0114409 - 14.5 x 25"
 48-8M0114408 - 14.5 x 26"

Highfive 60 Bigfoot Thru 125HP Prop D4



Part No.
 48-815744A6 - 13 x 22"

V6 S/S Highfive Prop D5



Part No.
 48-821154A46 - 17"
 48-815758A46 - 19"
 48-815760A46 - 21"

Tempest plus Prop D6



Part No.
 48-825872A47 - 14 5/8 x 24" R.H.
 48-825870A47 - 14 5/8 x 29" S/S.
 48-825863A47 - 14 5/8 x 21" L.H.
 48-8M8026820 - 14.625 x 22"
 48-825864A47 - 14 1/2 x 23" R.H.
 48-825865A47 - 14 5/8 x 23" L.H.
 48-825866A47 - 14 1/2 x 25" R.H.

Rubber Hub D7



Part No.
 43636T

*** Hub Kit OMC** D8



Part No.
 835265Q02
 8M0119081

*** Hub Kit Prop**

E1



Part No.
835283Q03 - 70Hp - 90Hp Suzuki

*** Flo-Torq Hub Kit 60BF-V6**

E2



Part No.
835257Q1

*** Flo-Torque II Hub Kit**

E3



Part No.
835281Q1
8352833Q1

*** Flo-Torque II Kit**

E4

Part No.
835257Q6
835258K1
835258Q1
835265A1
835265Q1
835266Q1
835267A1
835270Q1
835271Q2
835271A2
835272Q1
835274Q1
835278Q1
835282A1



*** Flo-Torque Hub Kit**

E5



Part No.
835-257Q9
835271Q09
835257K9

*** Flo-Torque IV Kit Verdo L4**

E6



Part No.
835257Q10

*** Hub Kit - H/D Prop**

E7



Part No.
840389Q06

Flo-Torque Drive Sleeve

E8



Part No.
835290Q1

Prop Sealing Ring F1



Part No.
878421

Prop Cover F2



Part No.
849492T01

Drive Sleeve Reflex F3



Part No.
8M0047148

Snubber Strip Kit F4



Part No.
840382A02 - High Performance Flo torque hub

Vent Plug F5



Part No.
19-889725 - Solid
19-889725047 - Large
19-889725T28 - Small
19-889725T35 - Medium

45 - 75 HP Large Gearcase - Evinrude / Johnson

A1

40 HP ETEC 2004 & Newer
 45 HP 2 Cyl. Commercial 1986 & Newer
 50 HP ETEC 2004 & Newer
 50 HP 2 Cyl. 1971-74
 50 HP 2 Cyl. Commercial 1977-79
 50 HP 3 Cyl. 1994-99
 55 HP 3 Cyl. 1968-69
 55 HP 2 Cyl. Commercial 1980 & Newer

60 HP ETEC 2004 & Newer 60 HP 3 Cyl. 1970-71, 1986 & Newer
 65 HP 3 Cyl. 1972-73
 65 HP 3 Cyl. Commercial 1984 & Newer
 70 HP 3 & 4 Cyl. 1974 & Newer (Including 4-Stroke)
 75 HP 3 Cyl. 1975-84
 75 HP ETEC 2004 & Newer
 13 Tooth Spline

Length (ft/m)	Current MPH/KPH	Propeller Size	Matl	Blades	Style	Quicksilver P/N	OEM P/N	Hub System
19-22 / 5.8-6.7	17-26 / 27-42	14 X 13 RH Extra cup	Al	3	Black Diamond	QA3832X	391668	1
17-19 / 5.2-5.8	23-31 / 37-50	13 3/4 X 13 RH	Al	3	Black Diamond	QA2208X	391198	1

Use Flo-Torque II attaching hardware kit 835266Q1. Purchase separately

85 - 140 HP V-4 Outboard - Evinrude / Johnson

A2

80 HP V-4 1969-80
 85 HP V-4 1991-95
 88 HP V-4 1981-96
 90 HP V-4 1981 & Newer
 90 HP ETEC 4004 & Newer
 100 HP V-4 1979-80
 100 HP V-4 1988-93
 110 HP V-4 1986-89
 112 HP V-4 1994-96

115 HP V-4 1973 & Newer
 115 HP ETEC 2004 & Newer
 120 HP V-4 1986-94
 125 HP V-4 1971-72
 130 HP ETEC 2004 & Newer
 135 HP V-4 1973-76
 140 HP V-4 1977-84
 13 Tooth Spline

Length (ft/m)	Current MPH/KPH	Propeller Size	Matl	Blades	Style	Quicksilver P/N	OEM P/N	Hub System
21-26 / 6.4-7.8	24-36 / 39-58	13 3/4 X 15 RH	Al	3	Black Diamond	QA2208X	391198	1
18-21 / 5.5-6.4	30-42 / 48-68	13 1/4 X 17 RH	Al	3	Black Diamond	QA2206X	391199	1
17-20 / 5.2-6.1	38-50 / 61-81	13 X 19 RH	Al	3	Black Diamond	QA2204X	390896	1
18-21 / 5.5-6.4	30-42 / 48-68	13 1/8 X 16 RH	SS	3	Silverado	QS5136X	389949	1
17-20 / 5.2-6.1	38-50 / 61-81	13 X 18 RH	SS	3	Silverado	QS5138X	389948	1

Use Flo-Torque II attaching hardware kit 835266Q1. Purchase separately

100 - 300 HP V-6 / V8 Outboard - Evinrude / Johnson

A3

100 HP V-4 Commercial 1984 & Newer 115 HP V-4 95 & Newer
 120 HP V-4 1985, 130 HP V-4 1995 & Newer
 140 HP V-4 (25") 1989-94, 140 HP V-4 1985
 150 HP V-4 Commercial 1993 & Newer
 150 HP V-6 1978 & Newer (Including ETEC)
 155 HP V-6 Commercial 1978 7 Newer
 175 HP V-6 1977 & Newer (Including ETEC)
 185 HP V-6 1984-85, 200 HP V-6 1976 & Newer

200 HP V-6 ETEC
 225 HP V-6 1986 & Newer, 250 HP V-8 1991 & Newer (Including ETEC)
 250 HP V-6 ETEC
 250 HP V-6 HO V-6 ETEC
 275-300 V-8 Two Strokes 1986-95
 300 HP V-6 ETEC
 15 Tooth Spline

Length (ft/m)	Current MPH/KPH	Propeller Size	Matl	Blades	Style	Quicksilver P/N	OEM P/N	Hub System
House / Cruises	24-36 / 39-58	15 1/2 X 15 RH	Al	3	Black Diamond	QA2008X	391535	1
21-26 / 6.4-7.8	30-42 / 48-68	15 X 17 RH	Al	3	Black Diamond	QA1912X	391200	1
19-22 / 5.8-6.7	36-49 / 58-79	14 1/2 X 19 RH	Al	3	Black Diamond	QA1916X	391201	1
21-26 / 6.4-7.8	30-42 / 48-68	15 X 16 RH	Al	4	Diamond 4	QA2182X		1
19-22 / 5.8-6.7	36-49 / 58-79	14 1/2 X 18 RH	Al	4	Diamond 4	QA2184X		1
19-22 / 5.8-6.7	36-49 / 58-79	14 X 19 RH	SS	3	Silverado	QS5054X	176617	1
17-20 / 5.2-6.1	42-56 / 68-90	13 3/4 X 21 RH	SS	3	Silverado	QS5056X	176619	1
19-22 / 5.8-6.7	36-49 / 58-79	14 X 19 RH	SS	3	Lightspeed	QS5070X	394752	1
17-20 / 5.2-6.1	42-56 / 68-90	13 7/8 X 21 RH	SS	3	Lightspeed	QS5072X	394753	1
15-19 / 4.5-5.8	50-64 / 81-103	13 3/4 X 23 RH	SS	3	Lightspeed	QS5074X	394754	1

Use Flo-Torque II hub kit 835265Q2 for 1991 and newer applications. Use Flo-Torque II hub kit 835267Q1 for 1990 and older applications. Purchase separately.

60 BFP, 75-130 HP - Honda

B1

60 BFP 1995 & Newer (Large Gearcase)
 75 HP 1995 & Newer
 90 HP 1995 & Newer
 115 HP 1998 & Newer
 130 HP 1998 & Newer
 15 Tooth Spline

Length (ft/m)	Current MPH/ KPH	Propeller Size	Matl	Blades	Style	Quicksilver P/N	OEM P/N	Hub System
19-24 / 5.8-7.3	30-33 / 48-53	13 3/4 X 15 RH	Al	3	Black Diamond	QA2034X	58130-ZW1-W21 ZA	1
17-21 / 5.2-6.4	36-39 / 58-63	13 1/4 X 17 RH	Al	3	Black Diamond	QA2036X	58130-ZW1-W31 ZA	1
Pontoon	24-27 / 39-44	13.8 X 13 RH	Al	4	Nemesis Pontoon	48-8M8027500		1
19-24 / 5.8-7.3	30-33 / 48-53	13.4 X 15 RH	Al	4	Nemesis	48-8M8027502		1
17-21 / 5.2-6.4	36-39 / 58-63	13 X 17 RH	Al	4	Nemesis	48-8M8027504		1
17-21 / 5.2-6.4	36-39 / 58-63	13 1/8 X 16 RH	SS	3	Silverado	QS5116X	58133-ZW1-A15AH	1
16-19 / 4.8-5.8	41-45 / 66-73	13 X 18 RH	SS	3	Silverado	QS5118X	58133-ZW1-A17AH	1

Use Flo-Torque II attaching hardware kit 835277Q1 for 75-90 HP thru 1998 or 835279Q2 for 75-90 HP 1999 and newer, 115-130 HP all years. Purchase separately

115D, 135-225 HP - Honda

B2

115D, 135-150 HP 2004 & Newer
 200-225 HP (4-Stroke) 2002 & Newer
 15 Tooth Spline

Length (ft/m)	Current MPH/ KPH	Propeller Size	Matl	Blades	Style	Quicksilver P/N	OEM P/N	Hub System
21-25 / 6.4-7.8	36-44 / 58-71	15 X 17 RH	Al	3	Black Diamond	QA1912X		1
19-23 / 5.8-7.0	42-50 / 68-81	14 1/2 X 19 RH	Al	3	Black Diamond	QA1916X		1
21-25 / 6.4-7.8	36-44 / 58-71	15 X 16 RH	Al	4	Diamond 4	QA2182X		1
19-23 / 5.8-7.0	42-50 / 68-81	14 1/2 X 18 RH	Al	4	Diamond 4	QA2184X		1
21-25 / 6.4-7.8	36-44 / 58-71	14 1/2 X 17 RH	SS	3	Silverado	QS5052X		1
19-23 / 5.8-7.0	42-50 / 68-81	14 X 19 RH	SS	3	Silverado	QS5054X		1
18-22 / 5.5-6.7	47-56 / 76-90	13 3/4 X 21 RH	SS	3	Silverado	QS5056X		1

Use Flo-Torque II attaching hardware kit 835278Q1. Purchase separately

9.9-25 HP - Mercury Mariner

B3

9.9 & 15 HP Bigfoot 4-Stroke 2005 & Older
 9.9 Sail Power 4-Stroke 2005 & Older
 18 HP Mercury 1980-85
 20 HP Mariner 1985 & Newer
 20 HP Mercury 2 Stroke 1986 & Newer
 25 HP Mercury 2 Stroke 1980 & Newer
 25 HP Mercury 2 Stroke 1985 & Newer
 25 HP SeaPro/Marathon
 10 Tooth Spline

Length (ft/m)	Current MPH/ KPH	Propeller Size	Matl	Blades	Style	Quicksilver P/N	OEM P/N	Hub System
15-20 / 4.5-6.1	11-24 / 18-34	10 3/8 X 11 RH	Al	3	Black Diamond	QA2102R	48-19638A40	Rubber Bushing
13-18 / 4.0-5.3	15-27 / 24-42	10.4 X 12 RH	Al	3	Black Diamond	48-8M0069665	48-19639A40	Rubber Bushing
12-15 / 3.6-4.5	19-30 / 31-48	10 3/8 X 13 RH	Al	3	Black Diamond	QA2106R	48-19640A40 (1)	Rubber Bushing

25 HP BigFoot, 30-70 HP Standard Gearcase Mercury / Mariner

C1

402-500 Mode Mercury 1974-76*, 402-500-700 Models Mercury 1977-84
 650 Model Mercury 1972-76*, 25 HP BigFoot 4-Stroke 1999-2005
 30 HP BigFoot 21010 & Newer
 30 HP 2 & 4-Stroke 1994-2005, 30 HP SeaPro/Marathon All Years
 35 HP 1984-89, 40 HP 2 & 4-Stroke (Not BigFoot) 1977 & Newer
 40 HP SeaPro/Marathon 1977 & Newer, 45 HP 1986-89
 48 HP Mariner All Years, 50 HP 2 & 4 Strokes (Not BigFoot) 1977 & Newer

55 HP SeaPro/Marathon 1995 & Newer, 60 HP Mariner 1976*
 60 HP 2 & 4-Stroke (Not BigFoot) 1978 & Newer, 70 HP 1983 & Older
 13 Tooth Spline
 Flo-Torque Reflex Propellers. Hub Kit included in box
 Note: Flo-Torque Propeller hardware is not compatible with older rubber hub
 propeller hardware

Length (ft/m)	Current MPH/KPH	Propeller Size	Matl	Blades	Style	Quicksilver P/N	OEM P/N	Hub System
17-20 / 5.2-6.1	18-22 / 29-35	11 1/4 X 10 RH	Al	3	Black Diamond	QA2064X	48-73132A45	Flo-Torque Reflex
15-18 / 4.5-5.5	23-28 / 37-45	10 3/4 X 12 RH	Al	3	Black Diamond	QA2072X	48-816702A45	Flo-Torque Reflex
15-18 / 4.5-5.5	23-28 / 37-45	10 5/8 X 12 RH	Al	4	Black Diamond	QA2074X	48-73134A45	Flo-Torque Reflex
14-18 / 4.2-5.5	27-32 / 44-52	10 1/2 X 13 RH	Al	4	Black Diamond	QA2076X	48-816704A45	Flo-Torque Reflex
14-16 / 4.2-4.8	31-35 / 50-56	10 3/8 X 14 RH	Al	3	Black Diamond	QA2080X	48-816706A45	Flo-Torque Reflex
14-16 / 4.2-4.8	31-35 / 50-56	10 1/4 X 14 RH	Al	3	Black Diamond	QA2082X	48-73138A45	Flo-Torque Reflex
13-15 / 3.9-4.5	34-39 / 55-63	10 1/8 X 15 RH	Al	3	Black Diamond	QA2084X	48-73140A45	Flo-Torque Reflex
15-18 / 4.5-5.5	23-28 / 37-45	10.6 X 12 RH	Al	4	Nemesis	48-8M8027511	48-8M8026625	Flo-Torque Reflex
14-18 / 4.2-5.5	27-32 / 44-52	10.3 X 13 RH	Al	4	Nemesis	48-8M8027512	48-8M8026630	Flo-Torque Reflex
14-16 / 4.2-4.8	31-35 / 50-56	10.1 X 14 RH	Al	4	Nemesis	48-8M8027513	48-8M8026635	Flo-Torque Reflex
15-18 / 4.5-5.5	23-28 / 37-45	11 X 12 RH	SS	3	Silverado	QS5164X	48-855856A46	Flo-Torque Reflex
14-18 / 4.2-5.5	27-32 / 44-52	10 1/2 X 13 RH	SS	3	Silverado	QS5166X	48-855858A46	Flo-Torque Reflex
14-16 / 4.2-4.8	31-35 / 50-56	10 3/8 X 14 RH	SS	3	Silverado	QS5168X	48-855860A46	Flo-Torque Reflex
to 15 / to 4.5	34-39 / 55-63	10 1/4 X 15 RH	SS	3	Silverado	QS5170X	48-855862A46	Flo-Torque Reflex

40-60 HP BigFoot, 70-140 HP Standard Gearcase

C2

650 Model (4 Cyl.) 1961-70, 650 Model (2 Cyl.) thru 1971
 900 to 1500 Models thru 1977, 60 HP SeaPro/Marathon ALL YEARS
 70 HP 1987-89, 75 HP 2 & 4-Stroke 1984 & Newer
 75 HP SeaPro/Marathon All Years, 80 HP Mariner 1977
 80 HP 1978-89, 90 HP 2 & 4-Stroke 1978 and Newer

100 HP 1988-99, 115 HP 2 & 4 Strokes 1978 and Newer
 125 HP 1994 and Newer, 140 HP 1978-81
 40 HP-60 HP BigFoot All Years
 15 Tooth Spline

Length (ft/m)	Current MPH/KPH	Propeller Size	Matl	Blades	Style	Quicksilver P/N	OEM P/N	Hub System
Pontoon	to 21 / to 34	14 X 11 RH	Al	3	Black Diamond	QA2830X	48-77338CP1	1
20" + / 6.1 +	19-27 / 31-44	14 X 13 RH	Al	3	Black Diamond	QA2032X	48-77340A45	1
18-20 / 5.5-6.1	25-32 / 40-52	13 3/4 X 15 RH	Al	3	Black Diamond	QA2034X	48-77342A45	1
17-19 / 5.2-5.8	30-38 / 48-61	13 1/4 X 17 RH	Al	3	Black Diamond	QA2036X	48-77344A45	1
15-18 / 4.5-5.5	35-41 / 56-66	13 X 19 RH	Al	3	Black Diamond	QA2038X	48-77346A45	1
Pontoon	to 21 / to 34	13.8 X 13 RH	Al	3	Nemesis Pontoon	48-8M8027500	48-8M8027500	1
18-20 / 5.5-6.1	25-32 / 40-52	13.4 X 15 RH	Al	4	Nemesis	48-8M8027502	48-8M8026580	1
17-19 / 5.2-5.8	30-38 / 48-61	13 X 17 RH	Al	4	Nemesis	48-8M8027504	48-8M8026590	1
15-18 / 4.5-5.5	35-43 / 56-66	12.5 X 19 RH	Al	4	Nemesis	48-8M8027506	48-8M8026600	1
17-19 / 5.2-5.8	30-38 / 48-61	13 1/8 X 16 RH	SS	3	Silverado	QS5116X	48-16986A46	1
15-18 / 4.5-5.5	35-41 / 56-66	13 X 18 RH	SS	3	Silverado	QS5118X	48-16988A46	1

For 2-Stroke carb applications use Flo-Torque II attaching hardware kit 835257Q1. For 4-Stroke and Opti-Max applications use Flo-Torque III attaching hardware kit 835257Q9 to reduce rattle. Purchase Separately.

135-350 HP - Mercury / Mariner

D1

135 HP 1987 & Newer, 150 HP 1978 & Newer
175 HP 1978 & Newer, 200 HP 1978 & Newer
220 HP 1987-88, 225 HP 1980 * Newer

225 HP SeaPro/Marathon All Years
250-350 HP 2 and 4-Stroke 1990 and Newer
15 Tooth Spline

Length (ft/m)	Current MPH/ KPH	Propeller Size	Matl	Blades	Style	Quicksilver P/N	OEM P/N	Hub System
22-27 / 6.7-8.2	30-38 / 48-61	15 1/2 X 15 RH	Al	3	Black Diamond	QA2008X	48-78116A45	2
21-25 / 6.4-7.8	36-44 / 58-71	15 X 17 RH	Al	3	Black Diamond	QA1912X	48-832828A45	2
19-23 / 5.8-7.0	42-50 / 68-81	14 1/2 X 19 RH	Al	3	Black Diamond	QA1916X	48-832830A45	2
19-23 / 5.8-7.0	42-50 / 68-81	14 1/2 X 18 RH	Al	4	Diamond 4	QA2184X	48-834852A45	2
18-22 / 5.5-6.7	47-56 / 76-90	14 X 20 RH	Al	4	Diamond 4	QA2186X	48-834854A45	2
21-25 / 6.4-7.8	36-44 / 58-71	14 1/2 X 17 RH	SS	3	Silverado	QS5052X	48-16314A46	2
19-23 / 5.8-7.0	42-50 / 68-81	14 X 19 RH	SS	3	Silverado	QS5054X	48-16316A46	2
18-22 / 5.5-6.7	47-56 / 76-90	13 3/4 X 21 RH	SS	3	Silverado	QS5056X	48-16318A46	2
19-23 / 5.8-7.0	42-50 / 68-81	14 X 19 RH	SS	3	Lightspeed	QS5070X	48-16544A46	2
18-22 / 5.5-6.7	47-56 / 76-90	13 7/8 X 21 RH	SS	3	Lightspeed	QS5072X	48-16546A46	2
17-20 / 5.2-6.1	53-61 / 85-98	13 3/4 X 23 RH	SS	3	Lightspeed	QS5074X	48-16548A46	2
21-25 / 6.4-7.8	36-44 / 58-71	14 X 17 RH	SS	3	Typhoon	QS6002X	48-825898A48	2
19-23 / 5.8-7.0	42-50 / 68-81	14 X 19 RH	SS	3	Typhoon	QS6004X	48-825900A48	2
18-22 / 5.5-6.7	47-56 / 76-90	14 X 21 RH	SS	3	Typhoon	QS6006X	48-825902A48	2

35-65 HP - Suzuki

D2

DT35C HP 1987-90
DT40, DF40 HP 1983 & Newer
DF50 1999 and Newer
DT50,50M HP 1983-84

DT55 HP 1985-97
DT60 HP 1983-84
DT65 HP 1985-97
13 Tooth Spline

Length (ft/m)	Current MPH/KPH	Propeller Size	Matl	Blades	Style	Quicksilver P/N	OEM P/N	Hub System
14-18 / 4.3-5.5	27-32 / 44-52	11 1/2 X 13 RH	Al	3	Black Diamond	QA2230R	58100-943-019	Rubber Bushing

60-70 HP (4-Stroke), 75-140 HP (2-Stroke) - Suzuki

D3

DF60 HP 1998 & Newer
DF70 HP 1998-2008
DT75 HP 1992-97
DT75 HP 1983-91

DT85 HP 1992-2000
DT85 HP 1979-91
DT90 HP 1989-97
DT100 HP 1989 and Newer

DT115, 140 HP 1992 & Newer
DT115, 140 HP 1981-91
13 Tooth Spline

Length (ft/m)	Current MPH/KPH	Propeller Size	Matl	Blades	Style	Quicksilver P/N	OEM P/N	Hub System
18-20 / 5.5-6.1	25-32 / 40-52	13 3/4 X 15 RH	Al	3	Black Diamond	QA2208X	58100-95500-019	1
17-19 / 5.2-5.8	30-38 / 48-61	13 1/4 X 17 RH	Al	3	Black Diamond	QA2206X	58100-95511-019	1
15-18 / 4.5-5.5	35-41 / 56-66	13 X 19 RH	Al	3	Black Diamond	QA2204X	58100-95521-019	1

Use Flo-Torque II attaching hardware kit 835282Q1. Purchase Separately.

70-140 HP (4-Stroke) - Suzuki

D4

DF70-100 HP 2009 and Newer

DF115-140 HP 2002 & Newer

15 Tooth Spline

Length (ft/m)	Current MPH/KPH	Propeller Size	Matl	Blades	Style	Quicksilver P/N	OEM P/N	Hub System
Pontoon	19-27 / 31-44	14 X 13 RH	Al	3	Black Diamond	QA2832X	77340CP1	1,2,3,4
18-20 / 5.5-6.1	25-32 / 40-52	13 3/4 X 15 RH	Al	3	Black Diamond	QA2034X	77342A45	1,2,3,4
17-19 / 5.2-5.8	30-38 / 48-61	13 1/4 X 17 RH	Al	3	Black Diamond	QA2036X	77344A45	1,2,3,4
15-18 / 4.5-5.5	35-41 / 56-66	13 X 19 RH	Al	3	Black Diamond	QA2038X	77346A45	1,2,3,4

For 90-115 HP 2001-2008 use Flo-Torque II attaching hardware kit 835283Q1. For 100-115 HP 2009 and newer use Flo-Torque II attaching hardware kit 835283Q2. For 140 HP use Flo-Torque II attaching hardware kit 835283Q2. For 70-90 HP and newer use Flo-Torque II attaching hardware kit 835283Q03

150-300 HP - Suzuki

E1

 DT150 / 150S HP 1986 & Newer
 DT175 HP 1986-92

 DT200 HP 1986-2000
 DT225 HP 1990 & Newer

 DF150 - DF300 All Years
 15 Tooth Spline

Length (ft/m)	Current MPH/KPH	Propeller Size	Matl	Blades	Style	Quicksilver P/N	OEM P/N	Hub System
21-25 / 6.4-7.8	36-44 / 58-71	15 X 17 RH	Al	3	Black Diamond	QA1912X		2
19-23 / 5.8-7.0	42-50 / 68-81	14 1/2 X 19 RH	Al	3	Black Diamond	QA1916X		2
18-22 / 5.5-6.7	47-56 / 76-90	14 1/4 X 21 RH	Al	3	Black Diamond	QA1918X		2
19-23 / 5.8-7.0	42-50 / 68-81	14 1/2 X 18 RH	Al	4	Diamond 4	QA2184X		2
18-22 / 5.5-6.7	47-56 / 76-90	14 X 20 RH	Al	4	Diamond 4	QA2186X		2
19-23 / 5.8-7.0	42-50 / 68-81	14 X 19 RH	SS	3	Silverado	QS5054X		2
18-22 / 5.5-6.7	47-56 / 76-90	13 3/4 X 21 RH	SS	3	Silverado	QS5056X		2
19-23 / 5.8-7.0	42-50 / 68-81	14 X 19 RH	SS	3	Lightspeed	QS5070X	99105-00200-20P	2
18-22 / 5.5-6.7	47-56 / 76-90	13 7/8 X 21 RH	SS	3	Lightspeed	QS5072X	99105-00200-22P	2
19-23 / 5.8-7.0	42-50 / 68-81	14 X 19 RH	SS	4	Typhoon	QS6004X		2

Use Flo-Torque II attaching hardware kit 835281Q1. Purchase Separately.

35-50 HP - Tohatsu / Nissan

E2

 35 HP (35B Only) 1984 and Earlier
 50 HP (50D Only) 1991
 40 HP 1984 and Newer

 50 HP 1992 and Newer
 13 Tooth Spline

Flo-Torque Reflex Propeller. Replace existing forward and aft washer with Quicksilver kit 8M0053074. Purchase separately.

Length (ft/m)	Current MPH/KPH	Propeller Size	Matl	Blades	Style	Quicksilver P/N	OEM P/N	Hub System
14-18 / 4.2-5.5	27-32 / 44-52	10 1/2 X 13 RH	Al	3	Black Diamond	QA2076X		Flo-Torque Reflex
14-16 / 4.2-4.8	31-35 / 50-56	10 3/8 X 14 RH	Al	3	Black Diamond	QA2080X		Flo-Torque Reflex
14-18 / 4.2-5.5	27-32 / 44-52	10 1/2 X 13 RH	SS	3	Silverado	QS5166X		Flo-Torque Reflex
14-16 / 4.2-4.8	31-35 / 50-56	10 3/8 X 14 RH	SS	3	Silverado	QS5168X		Flo-Torque Reflex
to 15 / to 4.5	34-39 / 55-63	10 1/4 X 15 RH	SS	3	Silverado	QS5170X		Flo-Torque Reflex

Replace existing forward thrust washer with Quicksilver thrust washer 8M0046466. Purchase Separately.

70-140 HP - Tohatsu / Nissan

E3

 70C HP 1996 & Newer
 90 HP 1987 & Newer

 115 HP 1992 & Newer
 120 HP 1988 & Newer

140 HP 1988 & Newer

Length (ft/m)	Current MPH/KPH	Propeller Size	Matl	Blades	Style	Quicksilver P/N	OEM P/N	Hub System
Pontoon	14-28 / 23-45	14 X 13 RH	Al	3	Black Diamond	QA2832X		1,2
21-26 / 6.4-7.8	24-36 / 39-58	13 3/4 X 15 RH	Al	3	Black Diamond	QA2034X	3B764-5360M	1
18-21 / 5.5-6.4	30-42 / 48-68	13 1/4 X 17 RH	Al	3	Black Diamond	QA2036X	3B764-5410M	1
17-20 / 5.2-6.1	38-50 / 61-81	13 X 19 RH	Al	3	Black Diamond	QA2038X	3B764-5451M	1

Use Flo-Torque II attaching hardware kit 835284Q1. Purchase Separately.

9.9-20 HP - Yamaha

E4

 9.9 HP 2-Stroke 1984 and Newer
 F9.9 4-Stroke 2000-2007

 15HP 2-Stroke 1984 and Newer
 F15 4-Stroke 2000 and Newer

 F20 4-Stroke All Years
 8 Tooth Spline

Length (ft/m)	Current MPH/KPH	Propeller Size	Matl	Blades	Style	Quicksilver P/N	OEM P/N	Hub System
14-19 / 4.3-5.8	19-24 / 31-39	9 1/4 X 9 RH	Al	3	Black Diamond	QA3906R	683-45945-00-EL	Rubber Bushing
14-16 / 4.3-4.8	23-27 / 37-44	9 1/4 X 10 RH	Al	3	Black Diamond	QA3914R	683-45943-00-EL	Rubber Bushing

20-30 HP - Yamaha

F1

20 HP 1996-97
25 HP 1980 and Newer

F25 4-Stroke 2000 and Newer
30 HP 1979 and Newer

F30 4-Stroke 2001 and Newer
10 Tooth Spline

Length (ft/m)	Current MPH/KPH	Propeller Size	Matl	Blades	Style	Quicksilver P/N	OEM P/N	Hub System
13-16 / 3.9-4.8	20-30 / 32-48	9 7/8 X 12 RH	Al	3	Black Diamond	QA3812R	664-45954-00-EL	Rubber Bushing

T25-60 HP - Yamaha

F2

T25 All Years
40 HP 1984 and Newer
F40 4-Stroke 1999 and Newer
48 HP 1995-2000

50 HP (Excluding T50) 1984 & Newer
F50 4-Stroke 1999 and Newer
55 HP 1976-95

60 HP 1976-91
F60 4-Stroke 2002 and Newer
13 Tooth Spline

Length (ft/m)	Current MPH/KPH	Propeller Size	Matl	Blades	Style	Quicksilver P/N	OEM P/N	Hub System
15-17 / 4.5-5.2	30-31 / 48-50	10 5/8 X 12 RH	Al	3	Black Diamond	QA2074X	6H5-45958-00-EL	1
14-17 / 4.2-5.2	31-35 / 50-56	10 3/8 X 13 RH	Al	3	Black Diamond	QA2078X	6H5-45943-00-EL	1
15-17 / 4.5-5.2	30-31 / 48-50	10.6 X 12 RH	Al	4	Nemesis	48-8M8027511		1
14-17 / 4.2-5.2	31-35 / 50-56	10.3 X 13 RH	Al	4	Nemesis	48-8M8027512		1
14-17 / 4.2-5.2	31-35 / 50-56	10 1/2 X 13 RH	SS	3	Silverado	QS5166X	663-45974-60-98	1
14-16 / 4.2-4.8	35-38 / 56-61	10 3/8 X 14 RH	SS	3	Silverado	QS5168X	663-45930-00-98	1
13-15 / 3.9-4.5	38-42 / 61-68	10 1/4 X 15 RH	SS	3	Silverado	QS5170X	663-45976-00-98	1

T50-130 HP - Yamaha

F3

T50 HP 4-Stroke 1996 and Newer
60 HP 1992 and Newer
T60 HP 4-Stroke 2003 and Newer
70 HP 1984 and Newer
75 HP 1994-2000
F75 4-Stroke 2003 and Newer

80 HP 1977, 2000 and Newer
F80 HP 4-Stroke 1999 and Newer
85 HP 1991-97
90 HP 1984 and Newer
F90 HP 4-Stroke 2003 and Newer
F100 HP 4-Stroke 2000 and Newer

115 HP 1984 and Newer
F115 HP 4-Stroke 2000 and Newer
130 HP 1984 and Newer
15 Tooth Spline

Length (ft/m)	Current MPH/KPH	Propeller Size	Matl	Blades	Style	Quicksilver P/N	OEM P/N	Hub System
Pontoon	19-27 / 31-44	14 X 13 RH	Al	3	Black Diamond	QA2832X		1,2
18-20 / 5.5-6.1	25-32 / 40-52	13 3/4 X 15 RH	Al	3	Black Diamond	QA2034X	6E5-45947-00-EL	1
17-20 / 5.2-6.1	30-38 / 48-61	13 1/4 X 17 RH	Al	3	Black Diamond	QA2036X	6E5-45945-00-EL	1
15-18 / 4.5-5.5	35-41 / 56-66	13 X 19 RH	Al	3	Black Diamond	QA2038X	6E5-45941-00-EL	1
Pontoon	19-27 / 31-44	13.8 X 13 RH	Al	4	Nemesis Pontoon	48-8M8027500		1
18-20 / 5.5-6.1	25-32 / 40-52	13.4 X 15 RH	Al	4	Nemesis	48-8M8027502		1
17-19 / 5.2-5.8	30-38 / 48-61	13 X 17 RH	Al	4	Nemesis	48-8M8027504		1
15-18 / 4.5-5.5	35-41 / 56-66	13 X 18 RH	SS	3	Silverado	QS5118X	688-45930-02-98	1
14-17 / 4.2-5.2	39-46 / 63-74	13 1/4 X 20 RH	SS	3	Lightspeed	QS5120X	688-45972-03-98	1

Use Flo-Torque II attaching hardware kit 835272Q1 on 50 to 100 HP applications and kit 835271Q2 on 115 & 130 HP units. Purchase Separately.

G1

150-300 HP - Yamaha

150 HP 1986 & Newer, F150 4-Stroke 2004 & Newer
 175 HP 1984 and Newer
 200 HP 1984 and Newer, F200 HP 4-Stroke 2002 and Newer
 220 HP Special 1984-85

225 HP Excel 1987-88
 225 HP 1986 and Newer, F225 HP 4-Stroke 2002 and Newer
 250 HP 1990 and Newer (Including VMAX), F250 HP 4-Stroke 2005 and Newer

300 HP 2003 and Newer, 300 HPDI 2004 and Newer
 15 Tooth Spline

Length (ft/m)	Current MPH/KPH	Propeller Size	Matl	Blades	Style	Quicksilver P/N	OEM P/N	Hub System
22-27 / 6.7-8.2	30-38 / 48-61	15 1/2 X 15 RH	Al	3	Black Diamond	QA2008X	6G5-45941-00-98	2
21-25 / 6.4-8.8	36-44 / 58-71	15 X 17 RH	Al	3	Black Diamond	QA1912X		2
19-23 / 5.8-7.0	42-50 / 68-81	14 1/2 X 19 RH	Al	3	Black Diamond	QA1916X		2
18-22 / 5.5-6.7	47-56 / 76-90	14 1/4 X 21 RH	Al	3	Black Diamond	QA1918X		2
19-23 / 5.8-7.0	42-50 / 68-81	14 1/2 X 18 RH	Al	4	Diamond 4	QA2184X		2
21-25 / 6.4-8.8	36-44 / 58-71	14 1/2 X 17 RH	SS	3	Silverado	QS5052X	6G5-45978-03-98	2
19-23 / 5.8-7.0	42-50 / 68-81	14 X 19 RH	SS	3	Silverado	QS5054X	6G5-45974-03-98	2
19-23 / 5.8-7.0	42-50 / 68-81	14 X 19 RH	SS	3	Lightspeed	QS5070X	MAR-GYT3B-V6-18	2
18-22 / 5.5-6.7	47-56 / 76-90	13 7/8 X 21 RH	SS	3	Lightspeed	QS5072X	MAR-GYT3B-V6-20	2

Use Flo-Torque II attaching hardware kit 835271Q2. Purchase Separately.

G2

Alpha One/Bravo One

Model 330TRS
 5.7 Litre 210-320 HP 1986 & Newer
 6.2 Litre 320 HP 2001 & Newer
 7.4 Litre 300-385 HP 1988 & Newer
 8.1 Litre 375-425 HP 2001 & Newer

8.2 Litre 390-415 HP 19990 & Newer
 Including 350, 454, 496 & 502 Mag. & 320 EFI
 Add 2" of pitch to suggested size for single engine applications 385 HP and above.

Caution! Check for adequate blade tip clearance when installing stainless steel propellers. If necessary, switch to Mercury trim tab 822777Q1 to ensure adequate blade clearance.

Length (ft/m)	Current MPH/KPH	Propeller Size	Matl	Blades	Style	Quicksilver P/N	OEM P/N	Hub System
25-29 / 7.6-8.8	40-46 / 65-74	15 X 17 RH	Al	3	Black Diamond	QA1912X	48-832828A45	2
23-26 / 7.0-7.9	46-51 / 74-82	14 1/2 X 19 RH	Al	3	Black Diamond	QA1916X	48-832830A45	2
22-25 / 6.7-7.6	51-56 / 82-90	14 1/4 X 21 RH	Al	3	Black Diamond	QA1918X	48-832832A45	2
23-26 / 7.0-7.9	46-51 / 74-82	14 1/2 X 18 RH	Al	4	Diamond 4	QA2184X	48-834852A45	2
22-25 / 6.7-7.6	51-56 / 82-90	14 X 20 RH	Al	4	Diamond 4	QA2186X	48-834854A45	2
27-30 / 8.2-9.1	29-40 / 47-65	14 1/2 X 15 RH	Al	4	Silverado	QS5050X	48-16312A46	2
25-29 / 7.6-8.8	40-46 / 65-74	14 1/2 X 17 RH	SS	3	Silverado	QS5052X	48-16314A46	2
23-26 / 7.0-7.9	46-51 / 74-82	14 X 19 RH	SS	3	Silverado	QS5054X	48-16316A46	2
25-29 / 7.6-8.8	40-46 / 65-74	13 1/2 X 17 RH	SS	5	QST 5	QS1154X	48-821154A46	2
23-26 / 7.0-7.9	46-51 / 74-82	13 1/3 X 19 RH	SS	5	QST 5	QS5758X	48-815758A46	2
22-25 / 6.7-7.6	51-56 / 82-90	13 1/3 X 21 RH	SS	5	QST 5	QS5760X	48-815760A46	2
23-26 / 7.0-7.9	46-51 / 74-82	14 X 19 RH	SS	3	Lightspeed	QS5070X	48-16544A46	2

Use Flo-Torque II attaching hardware kit 835257Q1 Order separate, except on 400 HP and above applications use solid hub kit 835258Q2. Order Separately.



SPARK PLUGS

All spark plugs carried are not contained in this section. Spark plugs shown here are the Mercury/Marine Outboard Service recommended replacements at time of printing.

2-Stroke - Outboard

A1

Model No.	Serial # Start	Serial # End	Recommended Spark Plug	Part No.
2.2	8075603		BPR6HS-10	A23-BPR6HS-10
3	0A855097	0G710612	BPR6HS-10	A23-BPR6HS-10
3.6	5404657 9252831 7145388		BP7HS-10	A23-BP7HS-10
3.9 (39)	1655013	2498135	B5HS	A23-B5HS
4 (40)(1 cyl.)	2498136	2771621	B5HS	A23-B5HS
4 (40, 1 cyl.)	2771622	0A809600	BUHW-2	33-97182Q
4 Gnat (40)(2 cyl.)	9075839 7085673	9256980 7146487	B6HS	A23-B6HS
4 (40)(2 cyl.)	5589202 8065265 9256981 7146488	5595531 8068064 9258280 7143687	BP7HS-10	A23-BP7HS-10
4 (40)(2 cyl.)	8065265 9256981 7146488	8068064 9258280 7143687	BPR7HS-10	A23-BPR7HS-10
4 (1 cyl.)	0A809601 9477830		BP7HS-10	A23-BP7HS-10
4 (1 cyl.), 5 (1 cyl.)	9477830		BPR7HS-10	A23-BPR7HS-10
4.5 (45, 1 cyl.)	4107220 8026540 9072179 7045758	0A809600 9477829	BUHW-2	33-97182Q
5 (1 cyl.)	0A809601 9477830		BP7HS-10	A23-BP7HS-10
6 (60)(60J)	2126764 2096171		B6HS	A23-B6HS
6 (60)	1408611 1958792	2126763 2096170	B6S	A23-B6S
6	0A197112 9461526	0T800749	BP8HN-10 BP8H-N-10	A23-BP8HN-10 (33-816737B2)
7.5 (75)	2529895 4851693 8051350 9181726 7111898	3801457 5226934 8058019 9219255 7136037	BUHW-2	33-97182Q
7.5 (75)	3801458 8015315 9043194 7028598	4851692 8051349 9181725 7111897	BUHW	33-97180Q
7.5	5206550 8057545 9217756 7125388		B9HS-10	A23-B9HS-10
9.8 (110)	1470349	2098251	B6S	A23-B6S
9.8 (110)	2098352	2798056	B7HS	A23-B7HS
9.8 (110)	3795658 8015040 9041439 7027323	4839253 8050624 9165304 7111347	BUHW	33-97180Q
9.8 (110)	2798057 4839254 8050625 9165303 7111384	3795657 5206549 8057544 9217755 7125387	BUHW-2	33-97182Q

All spark plugs carried are not contained in this section. Spark plugs shown here are the Mercury/Marine Outboard Service recommended replacements at time of printing.

2-Stroke - Outboard

A1

Model No.	Serial # Start	Serial # End	Recommended Spark Plug	Part No.
9.8	5206550 8057545 9217756 7125388		B9HS-10	A23-B9HS-10
9.9	0A197112 9461526	0T800749	BP8HN-10 BP8H-N-10	A23-BP8HN-10 (33-816737B2)
10 (100)	1290910	1499331	B6S	A23-B6S
10 (XR10/SEA PRO 10)	0D038000 9596000		BP8HS-15	A23-BP8HS-15
10 Magnum/Marathon	0D038000 9596000		BP8HS-15	A23-BP8HS-15
15 (150)	1290910	1499331	B6S	A23-B6S
15	0B292414 9542620		BP8HS-15	A23-BP8HS-15
15 SEA PRO/Marathon	0G438000 9927000		BP8HS-15	A23-BP8HS-15
15 Sea Pro/Marathon	0G044365	0G437999	BP8HN-10 BP8H-N-10	A23-BP8HN-10 (33-816737B2)
15 Sea Pro XD	9927000		BP8HN-10 BP8H-N-10	A23-BP8HN-10 (33-816737B2)
15 (Super 15)	0B238464 9507381 0A730007		BP8HN-10 BP8H-N-10	A23-BP8HN-10 (33-816737B2)
18 (18, 18XD)	5837437 8071973 9308306		BP8HN-10 BP8H-N-10	A23-BP8HN-10 (33-816737B2)
20 (20, 20XD)	6443973 9415101 7209533	0T800749	BP8HN-10 BP8H-N-10	A23-BP8HN-10 (33-816737B2)
20 JET	5705532 8073158 9315316 7166928		BP8HN-10 BP8H-N-10	A23-BP8HN-10 (33-816737B2)
20 (200)	1290910	1499331	B6S	A23-B6S
20 (200)	2094831	2827676	B7HS	A23-B7HS
20 (20,200)	2827677 8006265 9016254 7012358	6443972 9415100 7209532	BUHW-2	33-97182Q
25 (250)	1290910	1499331	B6S	A23-B6S
25 (25, 25XD, 20 JET)	5705532 8073158 9315316 7166928		BP8HN-10 BP8H-N-10	A23-BP8HN-10 (33-816737B2)
25 LIGHTNING (3 cyl.)	0E268781		B7HS	A23-B7HS
30 (300)	1271884	1960826	B6S	A23-B6S
30 (2 cyl.)644cc	0G053314 9854537	0T598999 0P206999	BP8HN-10 BP8H-N-10	A23-BP8HN-10 (33-816737B2)
30 JET (3 cyl.)	0G590000 9973100	0T178499 0P094499	BP8HN-10 BP8H-N-10	A23-BP8HN-10 (33-816737B2)
30 JET (4 cyl.)	0C159200 9570790	0G589999 9973099	BUHW-2	33-97182Q
35 (350, 35A)	1271884	1960826	B6S	A23-B6S
35 (350)	1960827	2097831	B7S	A23-B7S

All spark plugs carried are not contained in this section. Spark plugs shown here are the Mercury/Marine Outboard Service recommended replacements at time of printing.

2-Stroke - Outboard

A1

Model No.	Serial # Start	Serial # End	Recommended Spark Plug	Part No.
35 (350)	2097832	2874703	B7HS	A23-B7HS
35	6445653 9384476 7209608		BUHW	33-97180Q
40 (400)	1279685	1476509	B6S	A23-B6S
40 (40, 400, 402)	2874704 8002335 3339688 3340783	0G053313	BUHW	33-97180Q
40 (2 cyl.)	0G053314		BP8HN-10 BP8H-N-10	A23-BP8HN-10 (33-816737B2)
40 (3 cyl.)	0G531301 99 100		BP8HN-10 BP8H-N-10	A23-BP8HN-10 (33-816737B2)
40 (4 cyl.)	0C159200 9570790		BUHW-2	33-97182Q
40 JET	0T178500 0P094500		BP8HN-10 BP8H-N-10	A23-BP8HN-10 (33-816737B2)
45 (450)	1476510	1531568	B6S	A23-B6S
45 (4 cyl.)	5531630 8063985 9248006 7143688		BUHW-2	33-97182Q
45 JET	0G760300 0P017000	0T129554 0P094499	BP8HN-10 BP8H-N-10	A23-BP8HN-10 (33-816737B2)
50 (500)	1421113 1770179	2097444 2116317	B6S	A23-B6S
50 (500)	2097445 2863739 9001581 2116318	4357639 8029514 9107213 7068997	BUHW	33-97180Q
50 (50, 500)(4 cyl.)	4357640 8030090 9107214 7068998		BUHW-2	33-97182Q
50 (3 cyl.)	6428681 9385911 7208333	0D000749 9683054	BUHW	33-97180Q
50 (3 cyl.)	0D000750 9683055		BP8HN-10 BP8H-N-10	A23-BP8HN-10
55 (3 cyl.)	0D000750 9741042		BP8HN-10 BP8H-N-10	A23-BP8HN-10
60 (600)	1303411	1542744	B6S	A23-B6S
60 (3 cyl.)	6428681 9385911 7208333	0D000749 9683054	BUHW	33-97180Q
65 (650)(4 cyl.)	1542745	2119748	B7S	A23-B7S
65 (650S)(4 cyl.)	2119749	2309310	B7HS	A23-B7HS
65 (650SS)(4 cyl.)	2119749	2309310	BUHW	33-97180Q
60 (3 cyl.)	0D000750 9683055		BP8HN-10 BP8H-N-10	A23-BP8HN-10
65 (650)(3 cyl.)	3293184 8006640 9020074 7013633	4571651 9135824 7087822	BUHW	33-97180Q
65 JET	0D283222 9793577		BUHW-2	33-97182Q

All spark plugs carried are not contained in this section. Spark plugs shown here are the Mercury/Marine Outboard Service recommended replacements at time of printing.

2-Stroke - Outboard

A1

Model No.	Serial # Start	Serial # End	Recommended Spark Plug	Part No.
70 (700)	1296411	1566239	B6S	A23-B6S
70 (3 cyl.)	4571652 8042350 9135825 7087823	6428680 9385910 7208332	BUHW	33-97180Q
70 (3 cyl.)	0A996142 9483121	0C221999 9589038	BUHW-2	33-97182Q
75 (3 cyl. 1.5L Optimax)	0T980000		IZFR5J	33-892567Q
75 (4 cyl.)	6432907 9393856 7208573		BUHW-2	33-97182Q
75 (3 cyl.)	0C222000 9589039		BUHW-2	33-97182Q
80 (800)(6 cyl.)	1335465	1566239	B7S	A23-B7S
80 (800)(4 cyl.)	2559001	3493912	BUHW	33-97180Q
80 (80, 800)(4 cyl.)	4831999 8050200 9177626 7110998	6432900 9393855 7208572	BUHW-2	33-97182Q
80 (3 cyl.)	0A996142 9483121	0C221999 9589038	BUHW-2	33-97182Q
80 JET	0D283222 9793577		BP8HN-10 BP8H-N-10	A23-BP8HN-10
85 (850)(6 cyl.)	1460999	1766823	B7S	A23-B7S
85 (850)(4 cyl.)	3493913 8005440 9011604 7010108	4831998 8050199 9177625 7110997	BUHW	33-97180Q
90 (900)	1766824	1869775	B7S	A23-B7S
90 (90, 900)(6 cyl.)	4845301 8060545 7111698		BUHW	33-97180Q
90 (3 cyl. 1.5L Optimax),	0T801000		IZFR5J	33-892567Q
90 (3 cyl.)	0A996142 9483121		BUHW-2	33-97182Q
95 (950)	1869776	1962186	B7HS	A23-B7HS
95 (950)	1962187	2318585	BUHW	33-97180Q
100 (1000)	1464949	2318585	B7S	A23-B7S
100 (1000SS/1000BP)	2318586	3253111	BUHW	33-97180Q
100 (4 cyl.)	0B209468 9523034	0G960499 0P058999	BP8HN-10 BP8H-N-10	A23-BP8HN-10
110 (1100)	1870204	1962661	B7HS	A23-B7HS
110 (1100)	1962662	2314955	BUHW	33-97180Q
115 (115, 1150)(6 cyl.)	2836019 8008665 7010763		BUHW	33-97180Q
115 (4 cyl.)	0C100000 9559771		BP8HN-10 BP8H-N-10	A23-BP8HN-10
115 (3 cyl. 1.5L Optimax)	0T801000		IZFR5J	33-892567Q
115 Pro XS	1B751825		IZFR5J	33-892567Q
125 (1250)(6 cyl.)	2314956	3253111	BUHW	33-97180Q

All spark plugs carried are not contained in this section. Spark plugs shown here are the Mercury/Marine Outboard Service recommended replacements at time of printing.

2-Stroke - Outboard

A1

Model No.	Serial # Start	Serial # End	Recommended Spark Plug	Part No.
125 (4 cyl.)	0D283222 9793577		BP8HN-10 BP8H-N-10	A23-BP8HN-10
135 (1350)(6 cyl.)	2839369	3293233	BUHW	33-97180Q
140 (140, 1400)(6 cyl.)	3293234 8052650 7112773		BUHW	33-97180Q
150 (1500)(6 cyl.)	3502806 8005615 7010533	4865677 8052649 7112772	BUHW	33-97180Q
V-135	0A904646		BU8H	33-13686B2 (Mercury No - 33-13686Q)
V-135 DFI	0G590000		IZFR5G	33-889597Q
V-150 (150, 1500) Carb	4868998	0G960499	BU8H	33-13686B2 (Mercury No - 33-13686Q)
V-150 EFI	0A904646		BU8H	33-13686B2 (Mercury No - 33-13686Q)
V-150 (XR2/4/6/Magnum II/III)	4868998	0G960499	BU8H	33-13686B2 (Mercury No - 33-13686Q)
V-150 (XR2/4/6/Magnum II/III)	0G960500		BPZ8H-N-10	A23-BPZ8H-N-10
V-150 DFI	0G590000		IZFR5G	33-889597Q
V-150 ProXS	1B690542		IZFR6J	33-843220Q
V-150 EFI	0G960500		BPZ8H-N-10	A23-BPZ8H-N-10
V-175 (175, 1750) Carb	4301235 8058870	0G960499	BU8H	33-13686B2 (Mercury No - 33-13686Q)
V175 EFI	0D000750	0G960499	BU8H	33-13686B2 (Mercury No - 33-13686Q)
V-175 EFI	0G960500	0T800999	BPZ8H-N-10	A23-BPZ8H-N-10
V-175 DFI	0T178500		IZFR5G	33-889597Q
V-175 ProXS	1B516339		IZFR6J	33-843220Q
V-200 (200, 2000) Carb	4839034 8061595	0G960499 8065672	BU8H	33-13686B2 (Mercury No - 33-13686Q)
V-200 EFI	0C291521	0G960499	BU8H	33-13686B2 (Mercury No - 33-13686Q)
V-200 DFI	0G386496		IZFR5G	33-889597Q
V-200 EFI (2.5L)	0G960500		BPZ8H-N-10	A23-BPZ8H-N-10
V-200 EFI (3.0L)	0T750164		BR8HS	A23-BR8HS
V-200 Pro XS	1B504989		IZFR5G	33-889597Q
V-200 (200, 2000) Carb	0G960500		BPZ8H-N-10	A23-BPZ8H-N-10
V-200 EFI (3.0L)	0T750164		QL77CC	33-941
V-225 (2.4L)	5628028		BU8H	33-13686B2 (Mercury No - 33-13686Q)
V-225 (3.0L) Carb	0D280813	0G437999	BPZ8H-N-10	33-816837B2
V-225 (3.0L) Carb	0G438000		BR8HS	A23-BR8HS
V-225 Sea Pro & Marathon	0G245605		BR8HS	A23-BR8HS
V-225 EFI (3.0L)	0G129222		BR8HS	A23-BR8HS
V-225 DFI	0G590000		IZFR5G	33-889597Q
V-225 DFI (DTS)	0G590000		IZFR5G	33-889597Q

All spark plugs carried are not contained in this section. Spark plugs shown here are the Mercury/Marine Outboard Service recommended replacements at time of printing.

2-Stroke - Outboard

A1

Model No.	Serial # Start	Serial # End	Recommended Spark Plug	Part No.
V-225 ProXS	1B104549		IZFR6J	33-843220Q
V-250 (3.4L)	0C101891		BU8H	33-13686B2 (Mercury No - 33-13686Q)
V-250 ProXS	1B528615		IZFR6J	33-843220Q
V250 EFI (3.0L)	0G129222		BR8HS	A23-BR8HS
V-250 DFI (3.0L)	1B426561		IZFR6J	33-843220Q
V-275 (3.4L)	0C101891		BU8H	33-13686B2 (Mercury No - 33-13686Q)
V-300 (3.4L)	5611648		BU8H	33-13686B2 (Mercury No - 33-13686Q)

4-Stroke - Outboard

B1

Model No.	Serial # Start	Serial # End	Recommended Spark Plug	Part No.
2.5 FourStroke	0R131842		DCPR6E	33-803507
3.5 FourStroke	0R131842		DCPR6E	33-803507
4 FourStroke	0R000001 0P073456		DCPR6E	33-803507
5 FourStroke	0R000001 0P073456		DCPR6E	33-803507
6 FourStroke	0R000001 0P073456		DCPR6E	33-803507
8 FourStroke	0R042475 0P325500		DCPR6E	33-803507
8 FourStroke Bodensee	0P086824	0P325499	DPR6EA-9	33-827858Q
8 FourStroke Bodensee	0H000058 0G760300	0H107349 0T178499	CR6HS	33-827859
9.9 FourStroke	0R042475 0P325500		DCPR6E	33-803507
9.9 FourStroke	0G760300 0P075166	0T979999 0P325499	DPR6EA-9	33-827858Q
15 FourStroke (323cc)	0G590000 9973100	1B727495	DPR6EA-9	33-827858Q
15 FourStroke (351cc)	0R235949		DCPR6E	33-803507
20 FourStroke (Carb)	0R235168		DCPR6E	33-803507
25 FourStroke (Carb)	0G590000 9973100	1B344298 0P388282	DPR6EA-9	33-827858Q
25 FourStroke (EFI)	0R106999 0P401000		DCPR6E	33-803507
25 FourStroke JET	0R165086		DCPR6E	33-803507
25 FourStroke Carb	0G590000 9973100	1B344298 0P388282	DPR6EA-9	33-827858Q
30 FourStroke Carb	0G760300 0P094500	1B226999 0P400999	DPR6EA-9	33-827858Q
30 FourStroke (EFI)	0T409000	1B226999	RA8HC	33-883323001
30 FourStroke (EFI)	0R106999		DCPR6E	33-803507
40 FourStroke (3 cyl. Carb)	0G760300 0P094500	1B226999 0P400999	DPR6EA-9	33-827858Q
40 FourStroke (3 cyl. EFI)	0T409000 0P153500 1C000001		DCPR7E	33-883323001
40 FourStroke (4 cyl. Carb)	0T228405 0P094500	0T598999 0P206999	DPR6EA-9	33-827858Q
40 FourStroke (4 cyl. EFI)	0T409000 0P207000 1C000001		DCPR7E	33-883323001

All spark plugs carried are not contained in this section. Spark plugs shown here are the Mercury/Marine Outboard Service recommended replacements at time of printing.

4-Stroke - Outboard

B1

Model No.	Serial # Start	Serial # End	Recommended Spark Plug	Part No.
40 JET FourStroke (4 cyl. EFI)	1C051324		DCPR7E	33-883323001
40/45 FourStroke (4 cyl.)	0G231123	0T178499	DPR6EA-9	33-827858Q
40 FourStroke (4 cyl. Carb)	0T228405 0P094500	0T598999 0P206999	DRP6EA-9	33-827858Q
40 FourStroke (4 cyl. EFI)	0T409000 0P207000 1C000001		RA8HC	33-883323001
50 FourStroke	0G231123	0T178499	DPR6EA-9	33-827858Q
50 FourStroke Carb	0T178500 0P094500	0T598999 0P206999	DPR6EA-9	33-827858Q
50 FourStroke (EFI)	0T409000 0P207000 1C000001		DCPR7E	33-883323001
60 FourStroke Carb	0T178500 0P094500	0T598999 0P206999	DPR6EA-9	33-827858Q
60 FourStroke (EFI)	0T409000 0P207000 1C000001		DCPR7E	33-883323001
75 FourStroke (1.7L)	1B366823	2B366822	LFR5A-11	33-898829001
75 FourStroke (2.1L)	2B094996		ZFR5F	33-8M0057936
75 FourStroke (1596cc)	0G960500	1B366822	LFR5A-11	3859495Q
80 FourStroke (1.7L)	1B366823	2B094955	LFR4A-E	33-898829001
80 FourStroke (2.1L) 80 FourStroke	2B094956 0P401000		ZFR5F LFR4A-E	33-8M0057936 33-898829001
90 FourStroke (1.7L)	1B366823	2B094995	LFR4A-E	33-898829001
90 FourStroke (2.1L)	2B094996		ZFR5F	33-8M0057936
90 FourStroke (1596cc)	0G960500	1B366822	LFR5A-11	859495Q
100 FourStroke (1.7L)	1B366823	2B094995	LFR4A-E	33-898829001
100 FourStroke (2.1L) 100 FourStroke	2B094996 0P401000		ZFR5F LRF4A-E	33-8M0057936 33-898829001
115 FourStroke (1.7L)	1B366823	2B094995	LFR4A-E	33-898829001
115 FourStroke (EFI, 1741cc)	0T178500	1B366822	LFR6A-11	33-881284Q
115/115 ProXS FourStroke	2b094996		ZFR5F	33-8M0057936
135 Verado	1B227000 0P419487		ILFR6G-E	33-889246Q39
150 Verado	1B227000 0P419487		ILFR6G-E	33-889246Q39
150 EFI FourStroke	1B905505		ZFR5F	33-8M0057936
175 Verado	1B227000 0P464488		ILFR6G-E	33-889246Q39
200 Verado (4 & 6 Cyl.)	0T980000 0P409357		ILFR6G-E	33-889246Q39
225 FourStroke (EFI)	0T653945		LFR5A-11	859495Q
225 Verado	0T980000 0P409357		ILFR6G-E	33-889246Q39
250 Verado	0T980000 0P409357		ILFR6G-E	33-889246Q39
275 Verado	0T980000 0P409357		ILFR6G-E	33-889246Q39
300 Verado	0T980000 0P520553		ILFR6G-E	33-889246Q39
350 Verado	1B718256		ILFR6G-E	33-889246Q39

All spark plugs carried are not contained in this section. Spark plugs shown here are the Mercury/Marine Outboard Service recommended replacements at time of printing.

MerCruiser

C1

Model No.	Serial # Start	Serial # End	Recommended Spark Plug	Part No.
General Motors 4 cyl., 181 cid				
100 Vazer	1A035000			33-896329818
110	1537370	2044033	BR6ES	33-813471 1
120	1666601	3825578	BR6ES	33-813471 1
120	3825579	0B531853	BR6FS	33-898264001
2.5L	0B531854	0C853255	BR6FS	33-898264001
General Motors 4 cyl., 181 cid				
140	2508261	3826282	BR6ES	33-813471 1
140	3826283	0B450800	BR6FS	33-898264001
3.0L	0B450801	0C856558	BR6FS	33-898264001
3.0L	0C856559	0D504541	BR6FS	33-898264001
3.0L	0C856559	0D504541	BR6FS	33-898264001
3.0L	0D504542	0F603999	BPR6EFS	33-816336Q
3.0L	0L010042	0L340999	BPR6EFS	33-816336Q
3.0L	0L341000		TR5IX	33-862029
3.0L MPI	1A072812		TR5IX	33-862029
3.0LX	0C856559	0D504541	BR6FS	33-898264001
3.0LX	0C856559	0D504541	BPR6EFS	33-816336Q
3.0LX	0D504542	0K999999	BPR6EFS	33-816336Q
Mercury Marine 4 cyl., 224 cid				
165	0B434940	0B77451	BPR6EFS	33-97389
170	6916779	0B434940	BPR6EFS	33-97389
180	0B436391	0B775248	BPR6EFS	33-97389
190	6916779	0B436390	BPR6EFS	33-97389
3.7L	0B774252		BPR6EFS	33-97389
3.7LX	0B775249		BPR6EFS	33-97389
470	4208730	6916778	BPR6EFS	33-97389
485	5685394	6218036	BPR6EFS	33-97389
488	6170297	6916778	BPR6EFS	33-97389
General Motors 6 cyl., 250 cid				
140	1538930	1725960	BR6ES	33-813471 1
150	1666495	2048046	BR6ES	33-813471 1
160	2048022	2770031	BR6ES	33-813471 1
165	2770032	2771483	BR6ES	33-813471 1
165	2771484	5813433	BR6FS	33-898264001
200	2453769	2712072	BR6ES	33-813471 1
General Motors V6, 229 cid				
185 (4 bbl.)	6330183	6919655	BR6FS	33-898264001
General Motors V6, 262 cid				
185 (4 bbl.)	6330183	6919655	BR6FS	33-898264001
175	0B527955	0B773242	BR6FS	33-898264001
185 (2 bbl.)	6919656	0B527954	BR6FS	33-898264001
205	0A331455	0B775129	BR6FS	33-898264001
262 Mag.(TBI)(Gen+)	0F803800	0K999999	TR5IX	33-862029
4.3L	0B773243	0F000877	BR6FS	33-898264001
4.3L	0F000878	0F802999	BR6FS	33-898264001
4.3L (Gen +)	0L010044		TR5IX	33-862029
4.3L TKS	0W300013		MR43LTS	33-862029
4.3L EFI (Gen +)(TBI)	0L012009	0M299999	TR5IX	33-862029
4.3L MPI	0M300000		ITR4A15	33-8M2018369
4.3L MPI EC	1A637496		ITR4A15	33-8M2018369
4.3LH (Gen +)	0L010044	0M614999	TR5IX	33-862029

All spark plugs carried are not contained in this section. Spark plugs shown here are the Mercury/Marine Outboard Service recommended replacements at time of printing.

MerCruiser

C1

Model No.	Serial # Start	Serial # End	Recommended Spark Plug	Part No.
4.3LX	0B775130	0F001219	BPR6EFS	33-898264001
4.3LX	0F001220	0F802999	BPR6EFS	33-898264001
4.3LX (Gen +)	0F803000	0K999999	TR5IX	33-862029
4.3LXH (Gen +)	0F803000	0K999999	TR5IX	33-862029
General Motors V8, 283 cid				
4.5L MPI	2A441953		BPR5EPS	33-8M0095454
Ford V8, 302 cid				
215 MCM & MIE (Ford)	2781153	3563181	BR6FS	33-813425
225 MCM & MIE (Ford)	3385721	416699	BR6FS	33-813425
888 (Ford)	3108723	4887829	BR6FS	33-813425
General Motors V8, 305 cid				
198 MIE	4776402	4931099	BR6FS	33-898264001
200	6899058	0B774444	BR6FS	33-898264001
228	4765100	6218461	BR6FS	33-898264001
228	6218462	6899268	BR6FS	33-898264001
228 MIE	4765100	5907057	BR6FS	33-898264001
230	6899269	0B773739	BR6FS	33-898264001
230 MIE (LH)	5907058	0B788151	BR6FS	33-898264001
230 MIE (RH)	5907058	0B788151	BR6FS	33-898264001
5.0L	0B774445	0F600999	BR6FS	33-898264001
5.0L (Gen +)	0L015751	0W300009	TR5IX	33-862029
5.0L TKS	0W300010		TR5IX	33-862029
5.0L EFI (Gen +)	0L012052	0M299999	TR5IX	33-862029
5.0L MIE (LH)	0B788152	0C396832	BR6FS	33-898264001
5.0L MIE (RH)	0B788152	0C396832	BR6FS	33-898264001
5.0L MPI	0M300000		ITR4A15	33-8M2018369
5.0L MPI EC	1A300000		ITR4A15	33-8M2018369
5.0LX	0B773740	0F600999	BR6FS	33-898264001
898	4762210	6218461	BR6FS	33-898264001
898	6218462	6899057	BR6FS	33-898264001
General Motors V8, 350 cid				
225 MIE (GM)	2278647	2694014	AR6FS	33-813415
225 MCM & MIE	2314301	2639854	AR6FS	33-813415
General Motors V8, 350 cid				
250	4768000	4908849	BR6FS	33-898264001
255 MCM & MIE (GM)	3258728	4767999	BR6FS	33-898264001
260	4908850	6218461	BR6FS	33-898264001
260	6218462	0B77330A	BR6FS	33-898264001
260 MIE (LH)	5907058	0B788151	BR6FS	33-898264001
260 MIE (RH)	5907058	0B788151	BR6FS	33-898264001
270 MCM & MIE	2851074	3385720	AR6FS	33-813415
280 TRS	4176250	4499390	BR6FS	33-898264001
280 TRS	4499391	4770199	BR6FS	33-898264001
300	6668677	0B430367	BR6FS	33-898264001
320 EFI	0A543604	0C622418	BR6FS	33-898264001
350 Mag. Alpha	0A635178	0K999999	BR6FS	33-898264001

All spark plugs carried are not contained in this section. Spark plugs shown here are the Mercury/Marine Outboard Service recommended replacements at time of printing.

MerCruiser

C1

Model No.	Serial # Start	Serial # End	Recommended Spark Plug	Part No.
350 Mag. Alpha EFI (Gen +)	OK001509	OK999999	TR5IX	33-862029
350 Mag. Bravo MPI	OF415189	OF601999	BR6FS	33-898264001
350 Mag. Bravo MPI (Gen +)	OF602000	OK999999	TR5IX	33-862029
350 Mag. EFI Ski	OF215561	OK999999	TR5IX	33-862029
350 Mag. MPI (Gen +)	OL010019	OL325952	TR5IX	33-862029
350 Mag. MPI (Gen +)	OL325953	OM299999	TR5IX	33-862029
350 Mag. MPI	OM300000		ITR4A15	33-8M2018369
350 Mag. MPI EC	1A300000		ITR4A15	33-8M2018369
350 Mag. MPI Horizon	OM300000		ITR4A15	33-8M2018369
350 Mag. MPI Horizon MIE	OL304700	OM299999	TR5IX	33-8M0046007
350 Mag. MPI Horizon MIE	OM300000	1A089999	ITR4A15	33-8M2018369
350 Mag. MPI MIE (Gen +)	OL002008	OL302199	TR5IX	33-862029
350 Mag. MPI MIE (Gen +)	OL302200	OM299999	TR5IX	33-862029
350 Mag. MPI MIE	OM300000	1A089999	ITR4A15	33-8M2018369
350 Mag. MPI Ski	OF350583	OF799999	BR6FS	33-898264001
350 Mag. MPI Ski (Gen +)	OL002600	OL304599	TR5IX	33-862029
350 Mag. MPI Ski (Gen +)	OL304600	OM299999	TR5IX	33-862029
350 Mag. MPI Ski	OM300000		ITR4A15	33-8M2018369
350 Mag. Ski	OD505450	OK999999	BR6FS	33-898264001
5.7L	OB773305	OK999999	BR6FS	33-898264001
5.7L (Gen +)	OL010037	OW300754	TR5IX	33-862029
5.7L TKS	OW300755		TR5IX	33-862029
5.7L EFI	OF225560	OK999999	BR6FS	33-898264001
5.7L EFI (Gen +)	OL010035	OM299999	TR5IX	33-862029
5.7L EFI MIE (Gen +)	OK040300	OK999999	TR5IX	33-862029
5.7L MIE (LH)	OB788152	OF024999	BR6FS	33-898264001
5.7L MIE (RH)	OB788152	OF024999	BR6FS	33-898264001
5.7L MIE	OF025000	OK999999	BR6FS	33-898264001
5.7L MIE (Gen +)	OL002003	OW090899	TR5IX	33-862029
5.7 MIE TKS	OW090900		TR5IX	33-862029
5.7L MPI Horizon MIE	1A090000		ITR4A15	33-8M2018369
5.7L MPI MIE	1A090000		ITR4A15	33-8M2018369
5.7L MPI MIE EC	1A090000		ITR4A15	33-8M2018369
5.7L MPI Tow Sports	1A090000		ITR4A15	33-8M2018369
5.7L MPI Tow Sports EC	1A090000		ITR4A15	33-8M2018369
5.7L Ski	OA338553	OF775199	BR6FS	33-898264001
5.7L Ski	OB514627	OK999999	BR6FS	33-898264001
5.7L Ski	OL002005	OW090899	TR5IX	33-862029
5.7L Ski TKS	OW090900		TR5IX	33-862029
5.7LX	OF601000	OK999999	BR6FS	33-898264001
5.7LX Bravo EFI (Gen +)	OF800300	OK999999	TR5IX	33-862029
5.7LX EFI	OF752400	OK999999	BR6FS	33-898264001
Black Scorpion Ski (Gen +)	OF800000	OM391599	TR5IX	33-862029
Black Scorpion Ski (Gen +)	OM391600	OW698432	ITR4A15	33-8M2018369

All spark plugs carried are not contained in this section. Spark plugs shown here are the Mercury/Marine Outboard Service recommended replacements at time of printing.

MerCruiser

C1

Model No.	Serial # Start	Serial # End	Recommended Spark Plug	Part No.
Scorpion 350	0W698433		ITR4A15	33-8M2018369
Scorpion 350 EC	0W698433		ITR4A15	33-8M2018369
General Motors V8, 377 cid				
233 MCM & MIE (Ford)	4173000	4902304	AR6FS	33-813425
233 MIE & MCM (Ford)	3258728	5907057	AR6FS	33-813425
General Motors V8, 377 cid				
377 Mag	1A300000		ITR4A15	33-8M2018369
377 Mag EC	1A300000		ITR4A15	33-8M2018369
377 Scorpion MCM	0L416146	0M907201	TR5IX	33-862029
377 Scorpion Ski	0K000656	0L600314	TR5IX	33-862029
6.2L MPI (Mercury)	2A456613		BPR5EFS	33-8M0095454
MX 6.2L MPI	0L680003	0M299999	TR5IX	33-862029
MX 6.2L MPI	0M300000	1A299999	ITR4A15	33-8M2018369
MX 6.2L MPI Horizon	0M300000		ITR4A15	33-8M2018369
MX 6.2L MPI Horizon MIE	0M300000		ITR4A15	33-8M2018369
MX 6.2L MPI MIE	0L670000	0M299999	TR5IX	33-862029
MX 6.2L MPI MIE	0M300000		ITR4A15	33-8M2018369
MX 6.2L MPI MIE EC	1A090000		ITR4A15	33-8M2018369
MX 6.2L MPI Ski	0M317000		ITR4A15	33-8M2018369
MX 6.2L Blk Scorpion Kit	0L670015	0M391599	TR5IX	33-862029
MX 6.2L Blk Scorpion Kit	0M391750	0W698432	ITR4A15	33-8M2018369
Scorpion 377	0W698433		ITR4A15	33-8M2018369
Scorpion 377 HO EC	1A091488		ITR4A15	33-8M2018369
General Motors V8, 454 cid				
325 MCM & MIE	2278747		R5673-8	33-813421 4
330 MCM & MIE	4623115	6083144	BR6FS	33-898264001
330 MCM & MIE	4623115	6083144	R5673-8	33-813421 4
330	6083145	0B816540	BR6FS	33-898264001
340 MIE	5889914	0B788365	BR6FS	33-898264001
350 MIE	3780450	4623108	R5673-8	33-813421 4
370 TRS	4179554	6721527	R5673-8	33-813421 4
370 TRS	4883520	6721527	BR6FS	33-898264001
370 TRS	6721528	0B714586	BR6FS	33-898264001
400 TRS	5668232	0B457644	R5673-8	33-813421 4
400 TRS	5668232	0B457644	BR6FS	33-898264001
420	0A398941	0B622418	BR6FS	33-898264001
425	0B622419	0D937011	BR6FS	33-898264001
440 TRS	6181070	0B485220	R5673-8	33-813421 4
440 TRS	6181070	0B485220	BR6FS	33-898264001
450	0F347100	0F347277	BR6FS	33-898264001
454 Mag. Alpha	0A631894	0B785148	BR6FS	33-898264001
454 Mag. Bravo	0B721206	0K999999	BR6FS	33-898264001
454 Mag. EFI	0F115700	0F802349	BR6FS	33-898264001
454 Mag. EFI Ski	0F215800	0F820099	BR6FS	33-898264001
454 Mag. MPI	0F802350	0M024999	BR6FS	33-898264001
454 Mag. MPI Horizon MIE	0L002200	0L674000	BR6FS	33-898264001
454 Mag. MPI Ski	0F820100	0K999999	BR6FS	33-898264001
525 SC	0D456000	0L415623	BR6FS	33-898264001
7.4L Bravo	0B771113	0K999999	BR6FS	33-898264001
7.4L EFI MIE	0F874815	0K999999	BR6FS	33-898264001
7.4L MIE	5889914	0K999999	BR6FS	33-898264001
7.4L MPI (L29)	0L010003	0M024330	BPR6EFS	33-816336Q

All spark plugs carried are not contained in this section. Spark plugs shown here are the Mercury/Marine Outboard Service recommended replacements at time of printing.

MerCruiser

C1

Model No.	Serial # Start	Serial # End	Recommended Spark Plug	Part No.
7.4L MPI MIE	0F563052	0K999999	BR6FS	33-898264001
7.4L MPI MIE (L29)	0L002006	0L674613	BPR6EFS	33-816336Q
7.4LX Bravo EFI	0F820000	0K999999	BR6FS	33-898264001
7.4LX Bravo MPI	0F602010	0K999999	BR6FS	33-898264001
460 TRS				
460 TRS	6180970	6181046	R5673-8	33-813421 4
496 Mag & HO				
496 Mag & HO	0M025000		AC, 41-983	33-863622001
496 Mag & HO EC	1A066166		AC, 41-983	33-863622001
8.1S & HO MIE				
8.1S & HO MIE	0M026000		AC, 41-983	33-863622001
8.1S & HO MIE EC	0W697154		AC, 41-983	33-863622001
General Motors V8, 502 cid				
500	0F213293	0L001772	BR6FS	33-898264001
500 (Gen +)	0L414639	0L601036	BR6FS	33-898264001
500 EFI	0L001477		BR6FS	33-898264001
502 Mag.	0C878221	0F114528	BR6FS	33-898264001
502 Mag. EFI	0D840650	0F802599	BR6FS	33-898264001
502 Mag. MPI	0F802600	0M024999	BR6FS	33-898264001
525 EFI	0M900146		BPR6ES	33-810883
675 SCi	0L306696	0M950526	R5673-8	33-813421 4
600 SC	0D456489	0D763875	BR6FS	33-898264001
600 SC	0D763876	0F877642	R5673-8	33-813421 4
8.2L Mag	1A351597		BPR6ES	33-810883
8.2L Mag EC	1A350340		BPR6ES	33-810883
8.2L MIE	0C878221	0F819619	BR6FS	33-898264001
8.2L MIE	1A350802		BPR6ES	33-810883
8.2L MIE EC	1A350802		BPR6ES	31-810883
8.2L MPI MIE	0F819620	0L674200	BR6FS	33-898264001
General Motors V8, 540 cid				
500 Bulldog	0C577003	0F745405	BR6FS	33-898264001
500 Bulldog	0K000248	0M050281	BR6FS	33-898264001
575	0A677429	0D763716	R5673-8	33-813421 4

Earlier Mariner

D1

Model No.	Serial # Start	Serial # End	Recommended Spark Plug	Part No.
2A (M)			B6HS	A23-BR6HS
2B (M)	000101	011600	B6HS	A23-BR6HS
2B (M)	011601		B5HS	A23-BR5HS
3.5 (M)	0	23740	B7HS	A23-BR7HS
3.5 (ML)	0	41690	B7HS	A23-BR7HS
3.5 (M)	23741		B6HS	A23-BR6HS
3.5 (ML)	41691		B6HS	A23-BR6HS
4A (M, ML)			B7HS	A23-BR7HS
5A (M, ML)			B7HS	A23-BR7HS
5C (M, ML)			B7HS	A23-BR7HS
6C (M, ML)			B7HS-10	A23-BR7HS-10
6D (M, ML)			B7HS-10	A23-BR7HS-10
8A (M, ML)			B6HS	A23-BR6HS
8B (M, ML)			B7HS	A23-BR7HS
W8 (M, ML)			B7HS	A23-BR7HS
8 Marathon			B7HS	A23-BR7HS
K8 (M, ML)			B6HS	A23-BR6HS
8C (M, ML, MUL)			B7HS-10	A23-BR7HS-10
9.9C (M)	000551	032885	B7HS	A23-BR7HS
9.9C (ML)	300826	338410	B7HS	A23-BR7HS
9.9C (E)	250101	250945	B7HS	A23-BR7HS

All spark plugs carried are not contained in this section. Spark plugs shown here are the Mercury/Marine Outboard Service recommended replacements at time of printing.

Earlier Mariner

D1

Model No.	Serial # Start	Serial # End	Recommended Spark Plug	Part No.
9.9C (EL)	550141	552315	B7HS	A23-BR7HS
9.9C (M)	032886		B7HS-10	A23-BR7HS-10
9.9C (ML)	338411		B7HS-10	A23-BR7HS-10
9.9C (E)	250946		B7HS-10	A23-B7HS-10
9.9C (EL)	552316		B7HS-10	A23-BR7HS-10
15A (M, ML)			B7HS	A23-BR7HS
15C (M)	000101	020025	B7HS	A23-BR7HS
15C (ML)	300101	316415	B7HS	A23-BR7HS
15C (E)	250101	251060	B7HS	A23-BR7HS
15C (EL)	550101	551615	B7HS	A23-BR7HS
15C (M)	20026		B7HS-10	A23-BR7HS-10
15C (ML)	316416		B7HS-10	A23-BR7HS-10
15C (E)	251061		B7HS-10	A23-BR7HS-10
15C (EL)	551616		B7HS-10	A23-BR7HS-10
W15			B7HS	A23-BR7HS
W15B			B7HS	A23-BR7HS
W15 (Marathon)(M, ML, MUL)			B7HS-10	A23-BR7HS-10
K15 (M, ML)			B6HS	A23-BR6HS
K15 (M, ML)			B7HS-10	A23-BR7HS-10
20A (M, ML)			B6HS	A23-BR6HS
20C (M, ML, E, EL)			B7HS	A23-BR7HS
25A (M, ML, E, EL)			B7HS	A23-BR7HS
25C (M, ML, E, EL)			B7HS	A23-BR7HS
W25 (M, ML)			B7HS	A23-BR7HS
W25 (Marathon)(M, ML)			B7HS	A23-BR7HS
K25 (M, ML)			B7HS	A23-BR7HS
28 (M, ML, E, EL)			B7HS	A23-BR7HS
30A (M, ML, E, EL)			B7HS	A23-BR7HS
W30 (Marathon)(M, ML)			B7HS	A23-BR7HS
40A (M, ML, E, EL)			B8HS	A23-BR8HS
40B (M, ML, E, EL)			B8HS	A23-BR8HS
40C (M, ML, E, EL)			B8HS	A23-BR8HS
W40 (M, ML)			B8HS	A23-BR8HS
W40 (Marathon)(M, ML)			B7HS	A23-BR7HS
K40 (M, ML)			B7HS	A23-BR7HS
48 (M, ML)			B7HS	A23-BR7HS
W48 (M, ML)			B7HS	A23-BR7HS
55 (M, ML)			B8HS	A23-BR8HS
55 (E)	0	4040	B8HS	A23-BR8HS
55 (EL)	0	315378	B8HS	A23-BR8HS
55 (E)	4041		B8HS-10	A23-BR8HS-10

All spark plugs carried are not contained in this section. Spark plugs shown here are the Mercury/Marine Outboard Service recommended replacements at time of printing.

Earlier Mariner

D1

Model No.	Serial # Start	Serial # End	Recommended Spark Plug	Part No.
55 (EL)	315379		B8HS-10	A23-BR8HS-10
W55 (ML)			B7HS	A23-BR7HS
60 (E)	101	780	B8HS	A23-BR8HS
60 (EL)	300101	302050	B8HS	A23-BR8HS
60 (E)	781		B8HS-10	A23-BR8HS-10
60 (EL)	302051		B8HS-10	A23-BR8HS-10
60 (E, EL)			B8HS-10	A23-BR8HS-10

Evinrude - Outboard

E1

Model No.	Type	Capacity	Year	Cylinder	Engine	Gap	Recommended Spark Plug	Alternative
1.6	1.6 L 115-SD					1.0	B9HS-10	B9HS-10
1.8	1.8 L 140-SD					1.0	B9HS-10	B9HS-10
2			1975-1980			0.7	B6S	
2.6	2.6 L 190-SD					1.0	B9HS-10	B9HS-10
2.7	2.7 L 225-SD					1.0	B9HS-10	B9HS-10
3.6	3.6 L 275-SD					1.0	B9HS-10	B9HS-10
4	CDI		1987-			1.0	B9HS-10	B9HS-10
4	MAG		1987-			0.6	B6HS	BR6HS
4			1977-1980			1.0	B9HS-10	B9HS-10
4			1981-1986			0.6	B6HS	BR6HS
4.5			1979-1983			1.0	B9HS-10	BR9HS-10
6			1978-1979			0	BUHW-2	
6			1984-1986			1.0	B9HS-10	BR9HS-10
7.5			1980-1983			1.0	B9HS-10	BR9HS-10
8			1984-1987			1.0	B9HS-10	BR9HS-10
9.9	SAIL DRIVE		1978-1983			1.0	B9HS-10	BR9HS-10
9.9			1978-1979			0	BUHW-2	
9.9			1980-1987			1.0	B9HS-10	BR9HS-10
10	COMMERCIAL		1981-1982			0	BUHW-2	
14	COMMERCIAL		1981-			0	BUHW-2	
15	SAIL DRIVE		1981-1984			1.0	B9HS-10	BR9HS-10
15			1978-1979			0	BUHW-2	
15			1980-1987			1.0	B9HS-10	BR9HS-10
20			1985-1987			1.0	B9HS-10	BR9HS-10
25			1978-1986			1.0	B9HS-10	BR9HS-10
25			2003-2005			1.0	BPZ8HS-10	
28			1987-			1.0	B9HS-10	BR9HS-10
30			1984-1986			1.0	B9HS-10	BR9HS-10
35			1977-1987			1.0	B9HS-10	BR9HS-10

All spark plugs carried are not contained in this section. Spark plugs shown here are the Mercury/Marine Outboard Service recommended replacements at time of printing.

Evinrude - Outboard

E1

Model No.	Type	Capacity	Year	Cylinder	Engine	Gap	Recommended Spark Plug	Alternative
40	COMMERCIAL		1982-			0.7	B7HS	BR7HS
40	COMMERCIAL		1984-1987			0	BUHW-2	
40			1981-1987			1.0	B9HS-10	BR9HS-10
40			1982-			0.7	B7HS	BR7HS
40			2004-2005			0.8	PZFR6H	
48			1987-			1.0	B9HS-10	BR9HS-10
50			1978-1983			1.0	B9HS-10	BR9HS-10
55	COMMERCIAL		1982			1.0	B9HS-10	BR9HS-10
55	COMMERCIAL		1984-1985			1.0	B9HS-10	BR9HS-10
55	COMMERCIAL		1986			0	BUHXW-1	
55	COMMERCIAL		1987			0	BUHW-2	
55			1976-1983			1.0	B9HS-10	BR9HS-10
60			1980-1985			1.0	B9HS-10	BR9HS-10
60			2005-			0.8	PZFR6H	
65	COMMERCIAL		1984-1986			1.0	B9HS-10	BR9HS-10
65	COMMERCIAL		1987-			0	BUHW-2	
70			1975-1987			1.0	B9HS-10	BR9HS-10
75	HUSTLER		1975-			1.0	B9HS-10	BR9HS-10
75			1976-1985			1.0	B9HS-10	BR9HS-10
75			2001-2005			0.8	BKR5EK	
85			1987-1980			1.0	B9HS-10	BR9HS-10
90			1981-1987			1.0	B9HS-10	BR9HS-10
90			2001-2005			0.8	BKR5EK	
90	V4 EFI		2000-	4		0.8	PZFR6H	
100	COMMERCIAL		1984-			0	BUHW	
100	COMMERCIAL		1985-1987			0	BUHW-2	
100			1979-1980			1.0	B9HS-10	BR9HS-10
100			2004-2005			0.8	BKR5EK	
110			1986-1987			1.0	B9HS-10	BR9HS-10
115	E-TECH		2005-			0.8	IZFR5J	
115			1975-1984			1.0	B9HS-10	BR9HS-10
115			1985-			0	BUHW	
115			2004-2005			0.8	BKR5EK	
120			1985-1987			1.0	B9HS-10	BR9HS-10
125	COMMERCIAL		1990-			1.0	B9HS-10	BR9HS-10
140	140 S		1977-1979			0	BUHXW-1	
140			1973-1984			0	BUHXW-1	
140			1985-1992			1.0	B9HS-10	
150			1978-1987			0	BUHXW-1	
150			1988-1992			1.0	B9HS-10	BR9HS-10
155	COMMERCIAL		1978-1986			0	BUHXW-1	
155	COMMERCIAL		1987-			0	BUHW-2	

All spark plugs carried are not contained in this section. Spark plugs shown here are the Mercury/Marine Outboard Service recommended replacements at time of printing.

Evinrude - Outboard

E1

Model No.	Type	Capacity	Year	Cylinder	Engine	Gap	Recommended Spark Plug	Alternative
155	COMMERCIAL		1989-1992			0	BUZ8H	
175			1977-1987			0	BUHXW-1	
175			1988-1992			1.0	B9HS-10	BR9HS-10
175			2005-			0.8	IZFR5J	
185	COMMERCIAL		1984-1985			0	BUHXW-1	
185	COMMERCIAL		1990-1992			1.0	B9HS-10	
200	F MODELS		2005-			0.8	PZFR6H	
200	F MODELS		2005-			0.8	PZFR6H	
200	F MODELS		2005-			0.8	PZFR6H	
200			1976-1983			0	BUHXW-1	
200			1986-1992			1.0	B9HS-10	BR9HS-10
225	F MODELS		2005-			0.8	PZFR6H	
225			1986-			1.0	B9HS-10	BR9HS-10
235			1978-1985			0	BUHXW-1	
250	F MODELS		2005-			0.8	PZFR6H	
250			1991-1992			1.0	BR9HS-10	
275			1985-1988			1.0	BR9HS-10	
300			1986-1992			1.0	B9HS-10	BR9HS-10

Honda - Outboard

F1

Model No.	Type	Capacity	Year	Cylinder	Engine	Gap	Recommended Spark Plug	Alternative
8.0	BFP 8D1 8.0HP		2001-			0.9	CR5EH-9	
9.9	BFP9.9D1 9.9HP		2001-			0.9	CR5EH-9	
20	BF20					0.6	BM4A	BMR4A
20	BF20D		2003-			0.9	CR5EH-9	
25	BF25D4		2004-			0.7	DR7EA	
30	BF30				30HP	0.7	D8EA	DR8EA
30	BF30D4		2004-			0.7	DR7EA	
30	GB-30					0.6	B6HS	BR6HS
40	GB-40					0.6	B6HS	BR6HS
45	B45					0.6	D6HS	BR6HS
50	BF50				50HP	0.7	DR7EA	
60	BF60		2009-	3		0.9	LMAR6C-9	
75	B75 K					0.6	D6HS	DR6HS
75	BF75		2003-			0.7	DR7EA	
75	BF75 E					0.6	D6HS	DR6HS
75	BF75A				75HP	0.7	DR7EA	
100	BF100 E					0.6	D6HS	DR6HS
115	BF115				130HP	0.8	ZFR7F	
125	AQUA TRAX R-12		2002-2006			0.9	IMR9D-9H	
200	BF200A V6		2002-			1.1	IZFR6K-11	ZFR6K-11
225	BF225A V6		2002-			1.1	IZFR6K-11	ZFR6K-11

All spark plugs carried are not contained in this section. Spark plugs shown here are the Mercury/Marine Outboard Service recommended replacements at time of printing.

Johnson - Outboard

G1

Model No.	Type	Capacity	Year	Cylinder	Engine	Gap	Recommended Spark Plug	Alternative
1.5			1986-1987			0.7	B6S	
1.6	1.6 L 115-SD					1.0	B9HS-10	BR9HS-10
1.8	1.8 L 140-SD					1.0	B9HS-10	BR9HS-10
2	2R		1971-1979			0.7	B6S	
2			1980-1985			0.7	B6S	
2.5			1986-			1.0	B9HS-10	BR9HS-10
2.6	2.6 L 190-SD					1.0	B9HS-10	BR9HS-10
2.7	2.7 L 225-SD					1.0	B9HS-10	BR9HS-10
3.5			2001-2002			0.7	BPR6HS	
3.6	3.6 L 275-SD					1.0	B9HS-10	BR9HS-10
4	DEL.		1986-1987			1.0	B9HS-10	BR9HS-10
4	R,RW		1977-1980			1.0	B9HS-10	BR9HS-10
4			1985-1987			0.6	B6HS	BR6HS
4.5			1979-1980			1.0	B9HS-10	BR9HS-10
6			1977-1979			0	BUHW-2	
6			1984-1987			1.0	B9HS-10	BR9HS-10
7.5			1980-1983			1.0	B9HS-10	BR9HS-10
8			1984-1986			1.0	B9HS-10	BR9HS-10
8			2002-			0.7	DR5HS	
9.9	E, R, SEL		1977-1979			0	BUHW-2	
9.9			1980-1986			1.0	B9HS-10	BR9HS-10
10	COMMERCIAL		1981-1982			0	BUHW-2	
10			2006-2006			0.8	BR7HS	
14	COMMERCIAL		1981-1982			0	BUHW-2	
15	E, R		1977-1979			0	BUHW-2	
15			1980-1987			1.0	B9HS-10	BR9HS-10
15			2005-			0.8	BKR6E	
15			2006-			0.8	BRR7HS	
20			1986-1987			1.0	B9HS-10	BR9HS-10
25	COMMERCIAL		1985-1986			1.0	B9HS-10	BR9HS-10
25	E, R		1977-1979			0	BUHW-2	
25			1980-1986			1.0	B9HS-10	BR9HS-10
28			1985-1987			1.0	B9HS-10	BR9HS-10
30			1984-1987			1.0	B9HS-10	BR9HS-10
35	E, R		1977-1979			0	BUHW-2	
35			1980-1987			1.0	B9HS-10	BR9HS-10
40	40E		1985-1987			1.0	B9HS-10	BR9HS-10
40	COMMERCIAL		1981-			1.0	B9HS-10	BR9HS-10
40	COMMERCIAL		1982-			0.7	B7HS	BR7HS
40	COMMERCIAL		1984-1986			0	BUHW-2	
40		815	2002-			0.7	DCPR7E	
40			2005-			0.7	DCPRGE	

All spark plugs carried are not contained in this section. Spark plugs shown here are the Mercury/Marine Outboard Service recommended replacements at time of printing.

Johnson - Outboard

G1

Model No.	Type	Capacity	Year	Cylinder	Engine	Gap	Recommended Spark Plug	Alternative
45	COMMERCIAL		1987-			0	BUHW-2	
50	R		1977-1979			1.0	B9HS-10	BR9HS-10
50		815	2002-			0.7	DCPR7E	
50			1971-1980			0	BUHW-2	
50			1981-1987			1.0	B9HS-10	BR9HS-10
50			2005-			0.7	DCPR6E	
55	COM		1986-2005			0	BUHXW-1	
55	COMMERCIAL		1980-1983			0	BUHW	
55	COMMERCIAL		1984-1987			1.0	B9HS-10	BR9HS-10
55	E		1976-1979			0	BUHW	
60			1980-1987			1.0	B9HS-10	BR9HS-10
60			2002-2005			0.8	BPR6ES	BP6ES
65	COMMERCIAL HC		1984-1987			1.0	B9HS-10	BR9HS-10
65	COMMERCIAL LC		1986-			0	BUHXW-1	
70	EL		1976-1979			1.0	B9HS-10	BR9HS-10
70			1980-1986			1.0	B9HS-10	BR9HS-10
70			2002-2005			0.8	BPR6ES	BP6ES
75	ER		1976-1979			1.0	B9HS-10	BR9HS-10
75			1980-1987			1.0	B9HS-10	BR9HS-10
85	ML, ETLR, TXLR		1977-1978			1.0	B9HS-10	BR9HS-10
85	ML, TL, TX		1979-1980			1.0	B9HS-10	BR9HS-10
90			1981-1987			1.0	B9HS-10	BR9HS-10
90			2003-			0.8	BKR6E	
90			2006-			1.0	BPZ8HS-10	
100	COMMERCIAL		1980-			1.0	B9HS-10	
100	COMMERCIAL		1984-1987			0	BUHW-2	
100	ML, TLR, TXLR		1979-			1.0	B9HS-10	BR9HS-10
110			1986-1987			1.0	B9HS-10	BR9HS-10
115	115ETL		1974-1978			1.0	B9HS-10	BR9HS-10
115	115ML		1978-1979			1.0	B9HS-10	BR9HS-10
115	115TL		1979-			1.0	B9HS-10	BR9HS-10
115	115TXL		1977-1979			1.0	B9HS-10	BR9HS-10
115			1980-1985			1.0	B9HS-10	BR9HS-10
115			2006-			1.0	BPZ8HS-10	
120			1985-1987			1.0	B9HS-10	BR9HS-10
140	ML, TL, TXL		1977-1979			0	BUHXW-1	
140			1980-1984			0	BUHXW-1	
140			1985-1987			1.0	B9HS-10	BR9HS-10
140			2003-2005			0.8	BKR6E	
150	TL, TXL		1978-1979			0	BUHXW-1	
150			1980-1986			0	BUHXW-1	
150			1987-			0	BUHW-2	

All spark plugs carried are not contained in this section. Spark plugs shown here are the Mercury/Marine Outboard Service recommended replacements at time of printing.

Johnson - Outboard

G1

Model No.	Type	Capacity	Year	Cylinder	Engine	Gap	Recommended Spark Plug	Alternative
150			2003-2006			1.0	BPZ8HS-10	
155	COMMERCIAL		1984-1986			0	BUHXW-1	
175	TL, TXL		1977-1980			0	BUHXW-1	
175			1977-1986			0	BUHXW-1	
175			1987-			1.0	B9HS-10	BR9HS-10
185	COMMERCIAL		1984-1986			0	BUHXW-1	
200	TL, TXL		1976-1980			0	BUHXW-1	
200			1981-1986			0	BUHXW-1	
200			1987-			1.0	B9HS-10	BR9HS-10
225			1986-			0	BUHXW-1	
225			1987-			1.0	B9HS-10	BR9HS-10
235	TL, TXL		1978-1980			0	BUHXW-1	
235			1978-1985			0	BUHXW-1	
235			1981-1984			0	BUHXW-1	
250	LV6					0	BUZ8H	
250			1993-1991			1.0	BPZ8HS-10	
275			1985-1987			1.0	B9HS-10	BR9HS-10
300			1983-1986			1.0	BPZ8HS-10	
300			1994-1995			0.7	BPR6HS	

Suzuki - Outboard

H1

Model No.	Type	Capacity	Year	Cylinder	Engine	Gap	Recommended Spark Plug	Alternative
2	DT2					0.2	B5HS	BR5HS
3.5	DT3.5					0.6	BP6HS	BPR6HS
4	DT4		1985-			0.6	B6HS	BR6HS
4	DT4		1986-			0.6	BP6HS	BPR6HS
4	DF4		2003-2004			0.8	BPR6ES	BP6ES
5	DT5					0.6	BP6HS	BPR6HS
5	DT5W					0.6	BP6HS	BP6HS
6	DF6		2003-2004			0.8	BPR6ES	BP6ES
6	DT6		1985-			0.6	B6HS	BR6HS
6	DT6		1986-			0.6	BP6HS	BPR6HS
6	DF6		2003-2004			0.8	BPR6ES	BP6ES
6	DT6		1993-2002	2		0.8	BR6HS	
7	DT7		1985-			0.6	B6HS	BR6HS
8	DT8, C					0.6	BP6HS	BPR6HS
9.9	DF9.9		1996-2004	2	4 STROKE	0.7	DCPR6E	
9.9	DT9.9		1979-1983			0.6	B6HS	BR6HS
9.9	DT9.9C		1986-			0.7	B7HS	BR7HS
15	DF15		1996-2004	2	4 STROKE	0.7	DCPR6E	
15	DF152		1996-2004		4 STROKE	0.7	DCPR6E	

All spark plugs carried are not contained in this section. Spark plugs shown here are the Mercury/Marine Outboard Service recommended replacements at time of printing.

Suzuki - Outboard

H1

Model No.	Type	Capacity	Year	Cylinder	Engine	Gap	Recommended Spark Plug	Alternative
15	DT15		1983-			1.0	B7HS-10	BR7HS-10
15	DT15C		1984-			0.7	B7HS	BR7HS
15	DT15E		1983-			1.0	B7HS-10	BR7HS-10
15	DT15E		1984-			0.7	B7HS	BR7HS
15	DT15K		1986-			0.6	B6HS	BR6HS
16	DT16					0.7	B7HS	BR7HS
16	DT16P					0.7	B7HS	BR7HS
20	DT20		1985-			0.7	B7HS	BR7HS
20	DT20		1986-			1.0	B7HS-10	BR7HS-10
20	DT20P		1985-			0.7	B7HS	BR7HS
25	DF253		2000-2004	3	4 STROKE	0.7	DCPR6E	
25	DT25					0.7	B7HS	BR7HS
25	DT25E		1986-			1.0	B7HS-10	BR7HS-10
28	DT28					0.7	B7HS	BR7HS
30	DF303		2000-2004			0.7	DCPR6E	
30	DT30		1983-1985			1.0	B7HS-10	BR7HS-10
30	DT30C		1986-			1.0	B7HS-10	BR7HS-10
40	DF40		1999-2004	3		0.7	DCPR6E	
40	DT40, C					0.8	B8HS	BR8HS
50	DF50		1999-2004	3		0.7	DCPR6E	
50	DF50					0.7	DCPR6E	
50	DT50					0.8	B8HS	BR8HS
55	DT55, C					1.0	B8HS-10	BR8HS-10
60	DF60		1998-2004		4 STROKE	0.8	BPR6ES	BP6ES
60	DT60					1.0	B8HS-10	BR8HS-10
65	DT65, C					0.8	B8HS	BR8HS
70	DF70		1998-2004		4 STROKE	0.8	BPR6ES	BP6ES
75	DT75		1985-			0.8	B8HS	BR8HS
75	DT75C		1985-			0.8	B8HS	BR8HS
75	DT75C		1986-			1.0	B8HS-10	BR8HS-10
85	DT85, C					0.8	B8HS	BR8HS
90	DF90		2001-2004		4 STROKE	0.8	BKR6E	
100	DT100C					1.0	BR8HCS-10	
115	DF115		2001-2005		4 STROKE	0.8	BKR6E	
115	DT115/C					0.8	B8HS	BR8HS
140	DF140		2002-2004		4 STROKE	0.8	BKR6E	
140	DT140/C					0.8	B8HS	BR8HS
150	DT150		1987-2003			1.0	BR8HS-10	
150	DT150					0.8	B8HS	BR8HS
150	DT150C					1.0	B8HS-10	BR8HS-10
200	DT200TC					1.0	B8HS-10	BR8HS-10

All spark plugs carried are not contained in this section. Spark plugs shown here are the Mercury/Marine Outboard Service recommended replacements at time of printing.

Suzuki - Outboard

H1

Model No.	Type	Capacity	Year	Cylinder	Engine	Gap	Recommended Spark Plug	Alternative
225	DF225 V6		2004-2004			0.8	BKR6E	
225	DT225 EFI					1.0	B8HS-10	BR8HS-10
225	DT225 V6		1987-2003			1.0	BR8HS-10	
250	DF250 V6		2004-			0.8	BKR6E	

Tohatsu - Outboard

I1

Model No.	Type	Capacity	Year	Cylinder	Engine	Gap	Recommended Spark Plug	Alternative
2.5	M2.5A					0.6	BP6HS	BPR6HS
3.5	M3.5A		1985-			0.7	B7HS	BR7HS
3.5	M3.5A		1986-			0.6	BP6HS	BPR6HS
5	M5A2 S					0.7	B7HS	BR7HS
5	M5B S					0.7	BP7HS	
8	M8A					0.7	B7HS	BR7HS
9.8	M9.8A					0.7	B7HS	BR7HS
9.9	M9.9A					0.7	B7HS	BR7HS
9.9	M9.9B					1.0	B7HS-10	BR7HS-10
12	M12A					0.7	B7HS	BR7HS
12	M12B					0.7	B7HS	BR7HS
12	M12C					1.0	B7HS-10	BR7HS-10
15	M15A					0.7	B7HS	BR7HS
15	M15B					1.0	B7HS-10	BR7HS-10
16	M16A2					0.7	B7HS	BR7HS
18	M18A					0.7	B7HS	BR7HS
18	M18C		1982-1986			1.0	B7HS-10	BR7HS-10
20	M20A2					0.7	B7HS	BR7HS
25	M25A2					0.7	B7HS	BR7HS
25	M25B		1984-			0.7	B7HS	BR7HS
25	M25B		1985-			1.0	B7HS-10	BR7HS-10
25	M25C		1984-1986			1.0	B7HS-10	BR7HS-10
25	M25C2		1986-2006			1.0	B7HS-10	BR7HS-10
25	MSF25A		2004-2006	4 STROKE		0.7	DCPR6E	
30	M30A		1985-			0.7	B7HS	BR7HS
30	M30A		1986-			1.0	B7HS-10	BR7HS-10
30	M30A2		1984-			0.7	B7HS	BR7HS
30	M30A2		1985-			1.0	B7HS-10	BR7HS-10
30	M30A3		2004-2006			1.0	B7HS-10	BR7HS-10
30	MSF30A		2004-2006	4 STROKE		0.7	DCPR6E	
35	M35B					0.7	BP7HS	
40	M40C		1983-2006			1.0	B7HS-10	BR7HS-10
40	M40C		1984-			0.7	BP7HS	
40	M40C		1985-			1.0	B7HS-10	BR7HS-10

All spark plugs carried are not contained in this section. Spark plugs shown here are the Mercury/Marine Outboard Service recommended replacements at time of printing.

Tohatsu - Outboard

I1

Model No.	Type	Capacity	Year	Cylinder	Engine	Gap	Recommended Spark Plug	Alternative
40	MD40ATLDI		2004-2006			1.1	ZFR6F-11	
40	MD40BTLDI		2004-2006			0.8	PZFR6H	
50	M50C		2004-2006			1.0	B8HS-10	BR8HS-10
50	MD50ATLDI		2004-2006			1.1	ZFR6F-11	
50	MD50BTLDI		2004-2006			0.8	PZFR6H	
55	M55A					1.0	B8HS-10	BR8HS-10
55	M55B		2004-2006			1.0	B8HS-10	BR8HS-10
55	M55B					1.0	B8HS-10	BR8HS-10
60	M60A		2004-2006			1.0	B8HS-10	BR8HS-10
60	M60B		1992-2006			1.0	B8HS-10	BR8HS-10
70	M70A		2004-2006			1.0	B8HS-10	BR8HS-10
70	M70A					1.0	B8HS-10	BR8HS-10
70	MD70ATLDI		2004-2006			1.1	ZFR6F-11	
70	MD70BTLDI		2004-2006			0.8	PZFR6H	
90	M90A		1997-2006			1.0	BR8HS-10	
90	MD90ATLDI		2004-2006			1.1	ZFR6F-11	
90	MD90BTLDI		2004-2006			0.8	PZFR6H	
115	M115A		2004-2006			1.0	B8HS-10	BR8HS-10
120	M120A		2004-2006			1.0	B8HS-10	BR8HS-10
140	M140A		1997-2006			1.0	BR8HS-10	

Volvo-Penta - Outboard

J1

Model No.	Type	Capacity	Year	Cylinder	Engine	Gap	Recommended Spark Plug	Alternative
32						0.7	B7HS	BR7HS
33						0.7	B7HS	BR7HS
35						0.7	B7HS	BR7HS
39						0.7	B7HS	BR7HS
40						0.7	B7HS	BR7HS
50	A					0.7	B7HS	BR7HS
50						0.7	B7HS	BR7HS
80						0.5	B5HS	BR5HS
90						0.5	B5HS	BR5HS
92						0.7	B7HS	BR7HS
123						0.7	B7HS	BR7HS
124						0.7	B7HS	BR7HS
140						0.5	B5HS	BR5HS
151						0.5	B5HS	BR5HS
181						0.5	B5HS	BR5HS
200						0.8	B8HS	BR8HS
212						0.5	B5HS	BR5HS
243						0.6	B10HVX	

All spark plugs carried are not contained in this section. Spark plugs shown here are the Mercury/Marine Outboard Service recommended replacements at time of printing.

Volvo-Penta - Outboard

J1

Model No.	Type	Capacity	Year	Cylinder	Engine	Gap	Recommended Spark Plug	Alternative
250						0.7	BP7HS	
252						0.7	BP7HS	
280						0.8	B8HS	BR8HS
311						0.6	B10HVX	
342						0.6	B10HVX	
350						0.8	B8HS	BR8HS
392						0.6	B10HVX	
400						0.8	B8HS	BR8HS
450						0.8	B8HS	BR8HS
550	X					0.8	B8HS	BR8HS
550						0.8	B8HS	BR8HS
600						0.8	B8HS	BR8HS
700						0.8	B8HS	BR8HS

Volvo-Penta - Inboard

K1

Model No.	Type	Capacity	Year	Cylinder	Engine	Gap	Recommended Spark Plug	Alternative
2	MB2					0.6	D6HS	DR6HS
10	MB10A					0.6	BP6HS	BPR6HS
16	MB16A					0.7		
20	MB20A					0.6		
20	MB20B					0.5		
20	MB20C					0.5		
125	AQ125A					0.8		
130	AQ130					0.8		
150	AQ150					0.8		
170	AQ170					0.7		
210	AQ210A				177314	0.7		
210	AQ210A				177315	0.8		
225	AQ225					0.8		

Yamaha - Outboard

L1

Model No.	Type	Capacity	Year	Cylinder	Engine	Gap	Recommended Spark Plug	Alternative
2	2CMHS	50	1984-2002	1	2 STROKE	0.8	B5HS	BR5HS
2	A					0.6	B6HS	BR6HS
2	B	50	1984-	1	2 STROKE	0.5	B5HS	BR5HS
2	B		1985-			0.7	B7HS	BR7HS
2.5			2003-2005		4 STROKE	0.7	BR6HS	
3	3AMHS	70	1990-	1	2 STROKE	0.7	BR6HS	
3			1988-2002			0.8	BR6HS	
3.5	A					0.7	B7HS	BR7HS

All spark plugs carried are not contained in this section. Spark plugs shown here are the Mercury/Marine Outboard Service recommended replacements at time of printing.

Yamaha - Outboard

L1

Model No.	Type	Capacity	Year	Cylinder	Engine	Gap	Recommended Spark Plug	Alternative
3.5	AC					0.7	B7HS	BR7HS
3.5	AL					0.7	B7HS	BR7HS
4	A					0.7	B7HS	BR7HS
4	ACS					0.7	B7HS	BR7HS
4	AS					0.7	B7HS	BR7HS
4	F8CMHL	112	1999-2005	1	4 STROKE	0.7	BR6HS	
4			1999-2005		4 STROKE	0.7	BR6HS	
5	5CMHC	100	1985-2002	1	2 STROKE	0.8	BR7HS	
5	5CMHL	100	1984	1	2 STROKE	0.7	B7HS	BR7HS
5	DPE					1.0	B7HS-10	BR7HS-10
6	A					0.6	B6HS	BR6HS
6	B					0.5	B5HS	BR5HS
6			2001-2005		4 STROKE	0.8	BR6HS	
7	A					0.6	B6HS	BR6HS
8	8CMHL	165	2006-2010	2	2 STROKE	1.0	BR7HS-10	
8	8CMHS	165	2006-2010	2	2 STROKE	1.0	BR7HS-10	
8	A					0.6	B6HS	BR6HS
8	B					0.7	B7HS	BR7HS
8	BK					0.6	B6HS	BR6HS
8	E8DMHL	250	1986-2005	2	2 STROKE	1.0	BR7HS-10	
8	YEMS V8MTR 350 CUBIC INCH					0.8	BR6FS	
8			2001-2005		4 STROKE	0.8	BR6HS	
9	A					0.6	B6HS	BR6HS
9	F9.9		2005-	2	4 STROKE	0.9	DPR6EA-9	
9.5	A					0.7	B7HS	BR7HS
9.9	CPE CE C BE B					0.7	B7HS	BR7HS
9.9	D					1.0	B7HS-10	BR7HS-10
9.9	DE					1.0	B7HS-10	BR7HS-10
9.9	DPE					1.0	B7HS-10	BR7HS-10
9.9	DS					1.0	B7HS-10	BR7HS-10
9.9	F9.9 BM					0.7	C6HSA	CR6HSA
9.9	F9.9FMHL	212	1985-2004	2	4 STROKE	0.7	CR6HSA	
9.9	F9.9FMHS	212	1985-2004	2	4 STROKE	0.7	CR6HSA	
9.9	FT9.9GEL	212	1985-2004	2	4 STROKE	0.7	CR6HSA	
12	A					0.7	B7HS	BR7HS
15	15FMHL	250	2006-2010	2	4 STROKE	1.0	BR7HS-10	
15	15FMHS	250	2006-2010	2	4 STROKE	1.0	BR7HS-10	
15	A,B BE C CE CPE					0.7	B7HS	BR7HS
15	E15 AK					0.6	B6HS	BR6HS
15	E15DMHL	250	2006-2010	2	4 STROKE	1.0	BR7HS-10	
15	F15CMHL	360	1998-	2	4 STROKE	0.9	DPR6EA-9	
15	F15CMHS	360	1998-	2	4 STROKE	0.9	DPR6EA-9	

All spark plugs carried are not contained in this section. Spark plugs shown here are the Mercury/Marine Outboard Service recommended replacements at time of printing.

Yamaha - Outboard

L1

Model No.	Type	Capacity	Year	Cylinder	Engine	Gap	Recommended Spark Plug	Alternative
15			1998-2004	2	4 STROKE	0.9	DPR6EA-9	
20	A,B,AE					0.6	B6HS	BR6HS
20	BE					0.6	B6HS	BR6HS
20	BMK					0.6	B6HS	BR6HS
20	C,CE					0.7	B7HS	BR7HS
20	F20BMHS	360	1999-	2	4 STROKE	0.9	DPR6EA-9	
25	25BMHL	500	2006-2010	2	4 STROKE	1.0	BR7HS-10	
25	25BMHS	500	2006-2010	2	4 STROKE	1.0	BR7HS-10	
25	25N		1990-		4 STROKE	1.0	BR7HS-10	
25	AE A AF B BE C					0.7	B7HS	BR7HS
25	CE D DE					0.7	B7HS	BR7HS
25	CMK DMS DM					0.7	B7HS	BR7HS
25	E25BMHL	500	1984-2005	2	4 STROKE	1.0	BR7HS-10	
25	F25DEL	500	1998-2005	2	4 STROKE	0.9	DPR6EA-9	
25	F25DMHL	500	1998-2005	2	4 STROKE	0.9	DPR6EA-9	
25	F25DMHS	500	1998-2005	2	4 STROKE	0.9	DPR6EA-9	
25	A					0.7	B7HS	BR7HS
28	AE					0.7	B7HS	BR7HS
28	30HMHL	500	1987-2002	2	4 STROKE	1.0	BR7HS-10	
30	30HMHS	500	1987-2002	2	4 STROKE	1.0	BR7HS-10	
30	30HWL	500	1987-2002	2	4 STROKE	1.0	BR7HS-10	
30	A					0.7	B7HS	BR7HS
30	AE					0.7	B7HS	BR7HS
30	AM					0.7	B7HS	BR7HS
30	B					0.7	B7HS	BR7HS
30	BM					0.7	B7HS	BR7HS
30	D					1.0	BR7HS-10	BR7HS-10
30	DMS					1.0	BR7HS-10	BR7HS-10
30	F30		2001-2005		4 STROKE	0.9	DPR6EA-9	
30	40XMHL	700	1987-	2	4 STROKE	1.0	BR7HS-10	
40	40XMHS	700	2006-2010	2	4 STROKE	1.0	BR7HS-10	
40	40XWL	700	1992-	2	4 STROKE	1.0	BR7HS-10	
40	40XWTL	700	1989-	2	4 STROKE	1.0	BR7HS-10	
40	AE					0.8	B8HS	BR8HS
40	AM					0.8	B8HS	BR8HS
40	AR					0.8	B8HS	BR8HS
40	BE					0.8	B8HS	BR8HS
40	BM					0.8	B8HS	BR8HS
40	BR					0.8	B8HS	BR8HS
40	C					0.8	B8HS	BR8HS
40	CE					0.8	B8HS	BR8HS
40	CM					0.8	B8HS	BR8HS

All spark plugs carried are not contained in this section. Spark plugs shown here are the Mercury/Marine Outboard Service recommended replacements at time of printing.

Yamaha - Outboard

L1

Model No.	Type	Capacity	Year	Cylinder	Engine	Gap	Recommended Spark Plug	Alternative
40	D					0.8	B8HS	BR8HS
40	DM DE DR F FE					0.8	B8HS	BR8HS
40	E40XMHL	700	1989-1997	2	2 STROKE	1.0	BR7HS-10	
40	F40C					0.9	DPR5EA-9	
40	F40FEDL	750	2000-2005	3	4 STROKE	0.9	DPR6EA-9	
40	F40FEHDL	750	2000-	3	4 STROKE	0.9	DPR6EA-9	
40	F40FETL	750	2000-2005	3	4 STROKE	0.9	DPR6EA-9	
40	H					1.0	B7HS-10	BR7HS-10
40	HMOS					1.0	B7HS-10	BR7HS-10
40			1984-2005	3	2 STROKE	1.0	B7HS-10	BR7HS-10
48	A					0.7	B7HS	BR7HS
48	B					0.7	B7HS	BR7HS
50	50HETOL	700	2006-2010	3	2 STROKE	1.0	BR8HS-10	
50	50HMHOS	700	1984-2005	3	2 STROKE	1.0	BR8HS-10	
50	C					0.8	B8HS	BR8HS
50	CE					1.0	B8HS-10	BR8HS-10
50	D					1.0	B8HS-10	BR8HS-10
50	DROS					1.0	B8HS-10	BR8HS-10
50	F50A,B					0.9	DPR6EA-9	
50	F50GETL	1000	2005-	4	4 STROKE	0.9	DPR6EB-9	
50			2005-		4 STROKE	0.9	DPR6EB-9	
55	55BEDL	760	1989-1995	3	2 STROKE	1.0	BR8HS-10	
55	AE		1979			1.0	B8HS-10	BR8HS-10
55	AEM AE AM AW					0.8	B8HS	BR8HS
55	BE					1.0	B8HS-10	BR8HS-10
55	BM BW					0.8	B8HS	BR8HS
55	E55CMHL	760	1989-1995	2	2 STROKE	1.0	BR8HS-10	
60	60FETOL	850	2006-2010	3	2 STROKE	1.0	BR8HS-10	
60	AE		1978-			0.8	B8HS	BR8HS
60	AE		1979-			1.0	B8HS-10	BR8HS-10
60	B					1.0	B8HS-10	BR8HS-10
60	BE					1.0	B8HS-10	BR8HS-10
60	CE					1.0	B8HS-10	BR8HS-10
60	CET					1.0	B8HS-10	BR8HS-10
60	DE					1.0	B8HS-10	BR8HS-10
60	E60HMHDL	850	2001-2005	2	2 STROKE	1.0	BR8HS-10	
60	F					1.0	B8HS-10	BR8HS-10
60	F60 EFI		2005-		EFI	0.9	DPR6EB-9	
60	F60A 4 STR		2002-			0.9	DPR5EA-9	
60	FEOS					1.0	B8HS-10	BR8HS-10
60	FT60B 4 STR					0.9	DPR5EA-9	
60	FT60DET		2006-			0.9	DPR6EB-9	

All spark plugs carried are not contained in this section. Spark plugs shown here are the Mercury/Marine Outboard Service recommended replacements at time of printing.

Yamaha - Outboard

L1

Model No.	Type	Capacity	Year	Cylinder	Engine	Gap	Recommended Spark Plug	Alternative
60	FT60DETL	1000	1995-	4	4 STROKE	0.9	DPR5EA-9	
60	T 60		2005-		4 STROKE	0.9	DPR6EB-9	
60	T60 EFI		2005-		EFI	0.9	DPR6EB-9	
60			2001-2005		2 STROKE	1.0	BR8HS-10	
70	70BETOL	850	1984-1010	3	2 STROKE	1.0	BR8HS-10	
70	B					1.0	B8HS-10	BR8HS-10
70	BEOL					1.0	B8HS-10	BR8HS-10
70	F70AETL	1000	2010-	4	4 STROKE	0.8	LKR7E	
70	F70AETX	1000	2010-	4	4 STROKE	0.8	LKR7E	
75	25AETL	1140	1994-1999	3	2 STROKE	1.0	BR8HS-10	
75	75A		1988-			1.0	BR8HS-10	
75	A					1.0	B8HS-10	BR8HS-10
75	AE					1.0	B8HS-10	BR8HS-10
75	AEM					0.8	B8HS	BR8HS
75	AET					1.0	B8HS-10	BR8HS-10
75	AM					0.8	B8HS	BR8HS
75	AR					0.8	B8HS	BR8HS
75	F75		2003-2005		4 STROKE	1.1	LFR5A-11	
80	A					1.0	B8HS-10	BR8HS-10
80	AEOL					1.0	B8HS-10	BR8HS-10
80	F80BETL 16V	1600	1999-2002	4	4 STROKE	1.1	LFR5A-11	
80	F80BETX 16V	1600	1999-	4	4 STROKE	1.1	LFR5A-11	
85	85AEDC	1140	1989-1996	3	2 STROKE	1.0	BR8HS-10	
85	85AEDX	1140	1990-	3	2 STROKE	1.0	BR8HS-10	
85	85AETL	1140	1989-1996	3	2 STROKE	1.0	BR8HS-10	
85	85AETX	1140	1990-	3	2 STROKE	1.0	BR8HS-10	
85	AE					1.0	B8HS-10	BR8HS-10
85	AET					1.0	B8HS-10	BR8HS-10
90	90AETOL	1140	2006-	3	2 STROKE	1.0	BR8HS-10	
90	90AETOX	1140	2006-	3	2 STROKE	1.0	BR8HS-10	
90	A					1.0	B8HS-10	BR8HS-10
90	AEOL					1.0	B8HS-10	BR8HS-10
90	F9		2003-2005		4 STROKE	1.1	LFR5A-11	
100	F100BETL 16V	1600	2000-	4	4 STROKE	1.1	LFR5A-11	
100	F100BETX 16V	1600	2000-	4	4 STROKE	1.1	LFR6A-11	
100	F100DETL 16V	1600	2001-	4	4 STROKE	1.1	LFR5A-11	
100	F100DET X 16V	1600	1999-2002	4	4 STROKE	1.1	LFR5A-11	
115	115 CETOL	1730	2006-	3	2 STROKE	1.0	BR8HS-10	
115	115B					1.0	BR8HS-10	
115	115C		1990-			1.0	BR8HS-10	
115	AE					1.0	B8HS-10	BR8HS-10
115	AETOL BETO AET A					1.0	B8HS-10	BR8HS-10

All spark plugs carried are not contained in this section. Spark plugs shown here are the Mercury/Marine Outboard Service recommended replacements at time of printing.

Yamaha - Outboard

L1

Model No.	Type	Capacity	Year	Cylinder	Engine	Gap	Recommended Spark Plug	Alternative
115	E115AETL	1730	2006-2010	2	2 STROKE	1.0	BR8HS-10	
115	E115AETX	1730	2006-2010	2	2 STROKE	1.0	BR8HS-10	
115	F115AETL 16V	1700	2000-2010	4	4 STROKE	1.1	LFR6A-11	
115	F115AETX 16V	1440	2001-	4	4 STROKE	1.1	LFR6A-11	
115	FL115AETX 16V	1440	2001-	4	4 STROKE	1.1	LFR6A-11	
115	V4		2000-2005			1.1	LFR6A-11	
125	P125 A					0.6	B6HS	BR6HS
125	P125 AG					0.6	B6HS	BR6HS
130	130BETOL	1730	1990-	4	2 STROKE	1.0	BR9HS-10	
130	V 4		1988-2004			1.0	BR8HS-10	
140	140B		1988-			1.0	BR9HS-10	
140	BETO					1.0	B8HS-10	BR8HS-10
150	150 FETOL	2600	2006-	6	2 STROKE	1.0	BR8HS-10	
150	150 FETOX	2600	2006-	6	2 STROKE	1.0	BR8HS-10	
150	150A		1988-			1.0	BR8HS-10	
150	150C		1990-			1.0	BR8HS-10	
150	A		1986-			1.0	B8HS-10	BR8HS-10
150	AETOL					1.0	B8HS-10	BR8HS-10
150	F150AETL 16V	2700	2004-	4	4 STROKE	1.1	LFR6A-11	
150	F150AETX	2670	2004-2005	4	4 STROKE	1.1	LFR5A-11	
150	FL150AETX	2670	2004-	4	4 STROKE	1.1	LFR6A-11	
150	L 150A		1988-			1.0	BR8HS-10	
150	L 150FETOX	2600	1990-	6	2 STROKE	1.0	BR8HS-10	
150	LF 150		2004-2005		V6	1.1	LFR5A-11	
150	Z150QETOL HPDI	2600	2002-	6	2 STROKE	1.0	BR8HS-10	
175	VZ175		2002-2005			0.8	BKR7EKU	
200	200A		2988-			1.0	BR8HS-10	
200	200AETL	2600	1987-1995	6	2 STROKE	1.0	BR8HS-10	
200	200AETX	2600	1987-	6	2 STROKE	1.0	BR8HS-10	
200	200B		1990-			1.0	BR8HS-10	
200	200FETOL	2600	1999-2005	6	2 STROKE	1.0	BR8HS-10	
200	200FETOX	2600	1999-2005	6	2 STROKE	1.0	BR8HS-10	
200	200HP		2002-			1.1	LFR5A-11	
200	A					1.0	B8HS-10	BR8HS-10
200	AETOL					1.0	B8HS-10	BR8HS-10
200	200BETX	3350	2002-2005	6	4 STROKE	1.1	LFR5A-11	
200	F250DETC	4200	2008-	6	4 STROKE	1.1	LFR6A-11	
200	L 200B		1990-			1.0	BR8HS-10	
200	L200 FETOX	2600	2005-	6	2 STROKE	1.0	BR8HS-10	
200	L200AETX	2600	1999-2001	6	2 STROKE	1.0	BR8HS-10	
200	SX200		1999-2005		4 STROKE	0.8	BR8HS	
200	VX200		2000-2005			1.0	BR8HS-10	

All spark plugs carried are not contained in this section. Spark plugs shown here are the Mercury/Marine Outboard Service recommended replacements at time of printing.

Yamaha - Outboard

L1

Model No.	Type	Capacity	Year	Cylinder	Engine	Gap	Recommended Spark Plug	Alternative
200	VX200D		2005-			1.0	BR8HS-10	
200	Z200 F1		2002-			0.8	BKR7EKU	
200	Z200PETOL HPDI	2600	1999-	6	2 STROKE	1.0	BR8HS-10	
225	225A		1988-			1.0	BR9HS-10	
225	225B		1990-			1.0	BR9HS-10	
225	AETO					1.0	B8HS-10	BR8HS-10
225	F22AETU	3350	2005-	6	4 STROKE	1.1	LFR6A-11	
225	F225AETX	3350	2006-	6	4 STROKE	1.1	LFR6A-11	
225	F225CETL 24V	3350	2006-	6	4 STROKE	1.1	LFR6A-11	
225	F225DETC	4200	2002-2005	6	4 STROKE	1.1	LFR5A-11	
225	FL225AETU	3350	2005-	6	4 STROKE	1.1	LFR6A-11	
225	FL225AETX	3350	2006-	6	4 STROKE	1.1	LFR6A-11	
225	Z225HETOL HPDI	3350	1997-	6	2 STROKE	1.0	BR9HS-10	
250	F250AETU	3350	2005-	6	4 STROKE	1.1	LFR6A-11	
250	F250AETX	3350	2003-2005	6	4 STROKE	1.1	LFR6A-11	
250	F250BETU	3350	2006-	6	4 STROKE	1.1	LFR6A-11	
250	F250CETL	4200	2005-	6	4 STROKE	1.1	LFR5A-11	
250	FL250AETU	3350	2005-	6	4 STROKE	1.1	LFR6A-11	
250	FL250AETX	3350	2003-	6	4 STROKE	1.1	LFR6A-11	
250	FL250BETU	3350	2006-	6	4 STROKE	1.1	LFR6A-11	
300	VZ300		2004-2005				BKR6EKU	
300	Z300 2.3	2300	2005-	6	AETO	0.8	BKR6EKU	
350	F350AETU	5330	2005-	6	4 STROKE	1.1	LFR6A-11	
350	FL350AETU	5330	2005-	6	4 STROKE	1.1	LFR6A-11	
500	WJ					0.7	B7HS	BR7HS
500	WR					0.7	B7HS	BR7HS

Bombardier - Jet Ski

M1

Model No.	Type	Capacity	Year	Cylinder	Engine	Gap	Recommended Spark Plug	Alternative
580	GTS	580	1992-1997			0.8	BR7ES	
580	SP	580	1991-1997			0.8	BR7ES	
580	SPI	580	1993-1997			0.8	BR7ES	
718	GTI	718	2004-2005			1.1	BR8ES-11	
718	HX	718	1995-1997			0.8	BR8ES	
718	SPX	718	1996-1997			0.8	BR8ES	
787	GSX787, GTX787	787				0.8	BR8ES	
800	XP	800				0.8	BR8ES	
947	GTX DI	947	2007-			1.1	ZFR4F-11	
950	XP DI STD	950	2004-			1.1	ZFR4F-11	
951	GTX	951	2000-2003			1.1	ZFR5F-11	
951	LRV DI	951	2002-2003			1.1	ZFR5F-11	

All spark plugs carried are not contained in this section. Spark plugs shown here are the Mercury/Marine Outboard Service recommended replacements at time of printing.

Yamaha - Outboard

L1

Model No.	Type	Capacity	Year	Cylinder	Engine	Gap	Recommended Spark Plug	Alternative
951	RX DI	951	2000-2003			1.1	ZFR4F-11	
1500	RXP, RXT	1500	2007-			0.8	DCPR8E	
1503	GTI 4 TEC	1503	2007-2008			0.8	DCPR8E	
5599, 6115, 6162, 6163	BULLET	550	2004-			0.8	DCPR8E	
6135, 6136	GTI LE	718	2004-			0.8	BR8ES	
6137, 6138	GTI-RFI STD	782	2004-			0.8	BR8ES	
6141, 6142	GTX4-TEC LTD	1494	2004-			0.8	DCPR8E	
6147, 6148	GTX4-TEC LTD	1494	2004-			0.8	DCPR8E	
6151, 6152	XP-DISTD	781	2004-			1.1	ZFR4F-11	
6157	BARRACUDA, PREMIUM	782	2004-			0.8	BR8ES	
6158	BARRACUDA, PREMIUM	782	2004-			0.8	BR8ES	
GTI 6133, 6134	STD, LE, RFI	720	2004-			0.6	BR8ES	

Kawasaki - Jet Ski

N1

Model No.	Type	Capacity	Year	Cylinder	Engine	Gap	Recommended Spark Plug	Alternative
400	JS400A	400	1974-1975			0.8	B8ES	
550	JS, SX 550	550	1982-1995			0.8	BR8ES	
750	JS 750 SXI PRO	750	2003-			0.8	BR8ES	
750	JT750 SX1 PRO	750	2003-			0.8	BR8ES	
800	JS800SX-R	800	2003-			0.8	BR9ES	
800	SX R 800 JS 800A	800	2003-2008			0.8	BR8ES	
900	STX 900	900	2001-2006			0.8	BR9ES	
1100	STX 1100	1100	1997-1999			0.8	BR9ES	
1100	STX1100DI	1100	2002-			0.8	BR9ES	
1100	STX1100DI C1, F1	1100	2000-			0.8	PZFR7G-G	
1200	JH ULTRA 150	1200	2004-	4		0.8	BR9ES	
1200	STX 12F JT 1200B	1200	2003-2007			0.8	CR9EK	
1200	STX R JT1200C	1200	2004-2005			0.8	BR9ES	
1200	STX1200 12F	1200	2003-			0.8	CR9EK	
1200	STX1200F	1200	2004-			0.8	CR9EK	
1200	STX1200R	1200	2002-			0.8	BR9ES	
1500	STX	1500	2004-			0.8	CR9EK	
1500	STX-15F	1500	2004-2008			0.8	CR9EK	
1500	ULTRA 250X	1500	2007-			0.7	PMR9B	
1500	ULTRA LX JT1500C7F	1500	2007-2008			0.8	CR9EK	

All spark plugs carried are not contained in this section. Spark plugs shown here are the Mercury/Marine Outboard Service recommended replacements at time of printing.

Polaris - Jet Ski

O1

Model No.	Type	Capacity	Year	Cylinder	Engine	Gap	Recommended Spark Plug	Alternative
700	VIRAGE	700	2000-2004			0.8	BPR8ES	
701	FREEDOM	701	2002-2004			0.8	BPR8ES	
701	VIRAGE	701	2000-2004			0.8	BR8ES	
750	MSX110	750	2004-			0.8	BCPR7E	
750	MSX110	750	2004-			0.8	BCPR7E	
750	MSX750	750	2004-			0.8	BCPR7E	
777	OCTAINE	777	2002-2004			0.8	BR9ES	
777	OCTAINE	777	2002-2004			0.8	BR9ES	
777	VIRAGE	777	2002-2004			1.1	PZFR6H-11	
1165	GENESIS	1165	2002-2004			0.8	PZFR6H	
1165	VIRAGE INJECTION	1165	2001-			0.8	PZFR6H	
1192	MX140 JET SKI	1192	2003-2004			0.8	PZFR6H	

Sea Doo - Jet Ski

P1

Model No.	Type	Capacity	Year	Cylinder	Engine	Gap	Recommended Spark Plug	Alternative
610	BARRACUDA PREMIUM SP 6157/6158	610	2004-			0.8	B8ES	
718	GTI 718LE, LE RFI	718	2003-			0.8	BR8ES	
720	GTI STD, LE, RFE	720	2004-			0.8	BR8ES	
947	GTX947DI	947	2000-			1.1	ZFR5F-11	
947	RX947	947	2000-			1.1	ZFR5F-11	
951	GTX951DI	951	2000-			1.1	ZFR5F-11	
951	RX951DI	951	2003-			1.1	ZFR4F-11	
951	XP951LTD DI	951	2004-			1.1	ZFR4F-11	

Honda - Jet Ski

Q1

Model No.	Type	Capacity	Year	Cylinder	Engine	Gap	Recommended Spark Plug	Alternative
1200	AQUA TRAX F-12	1200	2002-	4		0.9	IMR9D-9H	
1200	ARX1200N2T2	1200	2004-2004	4		0.9	IMR9D-9H	
1200	ARX1200N3T2	1200	2002-2004	4		0.9	IMR9D-9H	

Yamaha - Jet Ski

R1

Model No.	Type	Capacity	Year	Cylinder	Engine	Gap	Recommended Spark Plug	Alternative
500	WJ500 WAVE JAMMER 500	500	1987-1990			1.0	BR7HS-10	
500	WJ500 WAVE RUNNER 500	500	1987-1994			1.0	BR7HS-10	
650	SJ650 SUPER JET	650	1990-1994			1.0	BR8HS-10	
650	WR650 WAVE RUNNER 650	650	1990-1992			1.0	BR8HS-10	

All spark plugs carried are not contained in this section. Spark plugs shown here are the Mercury/Marine Outboard Service recommended replacements at time of printing.

Yamaha - Jet Ski

R1

Model No.	Type	Capacity	Year	Cylinder	Engine	Gap	Recommended Spark Plug	Alternative
650	WR650A WAVE RUNNER 650A	650	1990-1993			1.0	BR8HS-10	
700	MARINE JET FX, XJ, VN700	700	1995-1997			0.8	BR8HS	
700	SUPER JET SJ700	700	1998			0.7	B7HS	
700	WB700	700	1993-1996			1.0	BR8HS-10	
700	WRA WAVE RUNNER	700	1995-1997			0.8	BR8HS	
760	MARINE JET RA, GP760	760	1996-1999			0.8	BR8HS	
800	MARINE JET GP800	800	1998			0.8	BR8HS	
800	WB800	800	1999-2002			0.8	BR8ES	
800	XL800	800	2000			0.8	BR9ES	
800	XLT800	800	2002			0.8	BR8ES	
1000	FX1000	1000	2003			0.8	CR9EB	
1000	WAVE RUNNER 1000	1000	2002-2008			0.8	CR9EB	
1100	MARINE JET RA1100	1100	1995-1997			0.8	BR8HS	
1100	VX DELUXE	1100	2008			0.8	BR9EB	
1100	VX SPORT VX-1100CB	1100	2005			0.8	BR9EB	
1100	VX1100G	1100	2008			0.8	BR9EB	
1200	GP R	1200	2000			1.1	BR8ES-11	
1200	GP1200	1200	2003			1.1	BR8ES-11	
1200	MARINE JET GP1200	1200	2003			0.8	BR8HS	
1200	XLT1200	1200	2001			1.1	BR8ES-11	
1300	GPR1300	1300	2003			1.1	BR8ES-11	
1300	WAVE RUNNER GP GP1300	1300	2003-2008			1.1	BR8ES-11	
1800	FX1800A-J	1800	2010	4	4STROKE	0.8	LFR6A	
1800	FX188J	1800	2010	4	4STROKE	0.8	LFR6A	
1800	GX1800A-H	1800	2009	4	4STROKE	0.8	LFR6A	
1800	GX1800H	1800	2009	4	4STROKE	0.8	LFR6A	



POWER ACCESSORIES

Fuel Tank 12 Litre

A1



Part No.

1200-8M0056211 - No Gauge
 1200-8M0047599 - With Gauge
 1200-8M0057252 - With Quick Connect

Fuel Tank 25 Litre

A2



Part No.

1200-8M0047603 - With Gauge
 1200-8M0057254 - Economy without Gauge

Fuel Tank 25 Litre

A3



Part No.

1200-8M0083451

Fuel Tank 3 Gallon

A4



Part No.

A23-C14541 - Without Gauge

Fuel Tank 6 Gallon

A5



Part No.

A23-C14540 - With Gauge

Fuel Tank 3 Gallon

A6



Part No.

A23-14541-G - With Gauge

Fuel Tank 6 Gallon

A7



Part No.

A23-C14548 - With Gauge

Big Joe Tank 22 Litre

A8



Part No.

A23-N0122001 - With Gauge

Big Joe 12 Litre B1



Part No.
A23-N0112003 - No Gauge

Big Joe Plastic Tank 30 Litre B2



Part No.
A23-N0129664 - No Gauge

Big Joe Tank 22 Litre B3



Part No.
A23-N0122003 - No Gauge

Fuel Can B4



Part No.
67-8313152 - 5 Litre
67-8313161 - 2.5 G (11) Litres

Fuel Can 20L B5



Part No.
67-8M9200702

UN Packaging Certified Fuel Tank 25 Litre Jerry Can B6

UN: 3H1/Y1.2/200/*
ZA/-AA2939



Part No.
A23-3010

Spares for Jerry Can B7



Part No.
A23-3011 - Spare Cap for Jerry Can
A23-34 - Bung for 25 Litre Jerry Can
A23-35 - Seal for Jerry Can

Fuel Sender Kit B8



Part No.
851052Q

Fuel Connectors

C1

**Part No.**

22-13563Q7 - Quick Connect for Standard Tank
 22-816856Q3 - Quick Connect - Engine End Male
 22-13563Q3 - Quick Connect - Engine End Female
 22-8M0072235 - International Type

Fuel Connector Kit

C2

**Part No.**

22-804787Q - Contains both fuel tank and engine end quick connectors.
 Suitable for 8mm fuel line bayonet assembly

Fuel Connect

C3

Old Merc / Mariner Twist Lock Type

**Part No.**

30635Q3 - Small Twist Lock Type
 22831Q3 - Large

Bayonet Assembly

C4

**Part No.**

30185Q3

Fuel Connector (Male)

C5

**Part No.**

A23-14510 - Yamaha Fuel Connector (Male)
 A23-14508 - OMC Connector

Yamaha Fuel Connector (Female)

C6

**Part No.**

A23-14536
 A23-N0111004

Yamaha Quick Fit

C7

**Part No.**

A23-8896LP6

Brass Barb

C8

**Part No.**

A23-14522 - 1/4" - For 22831A3 - connector
 A23-14523 - 1/8" - For 30185A3 - connector

Suzuki Fuel Connector D1



Part No.
A23-14527
A23-14535

Fuel Filler Hose D2



Part No.
A23-42543

Plastic Fuel Hose D3



Part No.
A23-N0108784 - 8mm I/D sold per meter
A23-N0110784 - 10mm I/D sold per meter

Fuel Line Assembly D4



Part No.
32-8M8026967 - No fittings (universal)
32-8M0054325 - 8' with fittings
32-8M0054326 - 12' with fittings

Fuel Line Low Permeation D5



Part No.
32-8M0038468 - 9' - 8mm
32-8M0038500 - 100' - 8mm
32-8M0038563 - 100' - 9.5mm

Yamaha Fuel Line Primer Bulb and Connector (2m) D6



Part No.
A23-14620
A23-N0102060

Universal Fuel Hose with Primer Bulb (2m) D7



Part No.
A23-14634
A23-C44634
A23-N0100028

Bulk Fuel Line D8



Part No.
A23-14660 - 8m
A23-44669 - 15.5m
A23-N0108004 - 25m

Brass 3-Way Valve

E1



Part No.
A23-14565

Primer Bulb Quicksilver

E2



Part No.
8M0054313 - 8mm Q1
8M0054315 - 6mm 1/4" Q1

Fuel Primer Bulb

E3



Part No.
A23-14572 - Regular
A23-N0134095 - Regular
A23-N0114672 - X-Large
A23-40061 - Jumbo
A23-C14782 - Dual Layer
A23-C14784 - Single Layer

Fuel Filter

E4



Part No.
35-8M0032639 - 5 GPM
35-8M0032640 - 12 GPM

Water Separating Fuel Filters

E5



Part No.
A23-C14568 -
Use with Reusable Bowl Filter only
A23-C14570P -
Use with Reusable Bowl Filter and Bowl
A23-C14575P -
Use with Reusable Bowl Filter, Bowl and Bracket

Racor with Separating Filter

E6



Part No.
35-809096 - With Bowl - 35-8M0116793
35-809097 - Without Bowl - 35-8M0103095

Fuel Filter (Bracket only)

E7



Part No.
89876A3

Fuel Filter Replacement for 35-802893Q4

E8



Part No.
35-802893Q01

Fuel Filter Kit (Complete) F1



Part No.
35-802893Q4

Universal Glass Fuel Filter F2



Part No.
A23-13191FF - Universal Glass Fuel Filter
A23-1318UFF - Replacement Filter Kit

Flushing Kit F3



Part No.
16841Q02

Flushing Attachments for Mariner / Mercury F4



Part No.
12612Q2 - 6, 8, 9.9 15Hp
44357Q2 - Merc /Mar 20Hp and Higher, 9.9 / 15 4-Stroke

Flush Muff F5

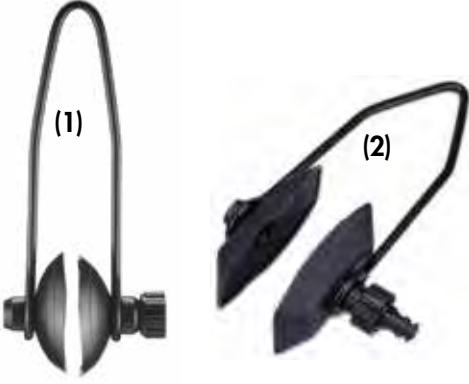

Part No.
A23-2006 - (1)
A23-72590 - (2)

Outboard Motor Flusher Deluxe F6



Part No.
A23-10963

Outboard Motor Lock F7



Part No.
67-808912

Battery Box F8



Part No.
A23-C11524 - Standard
A23-C11525 - Large
A23-C87019 - Extra Large
A23-77000-S - Black 275mm x 185mm x 205mm
A23-77000-L - Large Black 340mm x 185mm x 205mm

Battery Box XL

G1



Part No.
A23-N0114546 - Combined 197mm x 337mm x 368mm (h)

Battery Holder

G2



Part No.
A23-C11499 - 13" x 7" 24-27 Series

Battery Tool Holder

G3



Part No.
A23-N0141250 - 200mm x 410mm x 200mm (h)
A23-N0138120 - 190mm x 270mm x 200mm (h)

Battery Hold Down Straps

G4



Part No.
A23-11530

Oil Change Pump

G5



Part No.
802889Q1

Oil/Fluid Extractor 18 Litre

G6



Part No.
A23-OM-11198

Outboard Motor Support

G7



Part No.
A23-11096

Fill Kit - Deck (Oil)

G8



Part No.
15969A09

Jiggler Syphon Brass H1



Part No.
A23-C11801 - 1/2"
A23-C11800 - 3/4"

Portable Oil Change Kit H2



Part No.
A23-C24540

Filter Oil Element H3



Part No.
A23-C14559 - Mercury Type

Oil Change Kit 12V H4



NO IMAGE
AVAILABLE

Part No.
A23-C24541

Rigging Flange W-Fuel H5



Part No.
A23-RFFHP-1-DP

Rigging Flange Hose Union H6



Part No.
A23-RFHU-1-DP

Oil / Fluid Extractor Pump 6.5L H7



Part No.
A23-18547-L

Stingray Classic Junior H8

On plane up to 50% faster!
Reduced bow rise
Eliminates chinewalking
Stops porpoising
Wipes out cavitation
Delivers true stabilization
30-40% fuel efficiency
increase Aids in pulling
skiers



Part No.
A23-JR-1 - Black
A23-JR-3 - Grey

Stingray Classic Senior

11

On plane up to 50% faster!
 Reduced bow rise
 Eliminates chinewalking
 Stops porpoising
 Wipes out cavitation
 Delivers true stabilization
 30-40% fuel efficiency
 increase Aids in pulling
 skiers

**Part No.**

A23-SR-1 - Black
 A23-SR-3 - Grey

Stingray Classic Star Fire

12

NO-DRILL installation
 Greater top-end speed
 Greater fuel savings
 Simplest, quickest installation

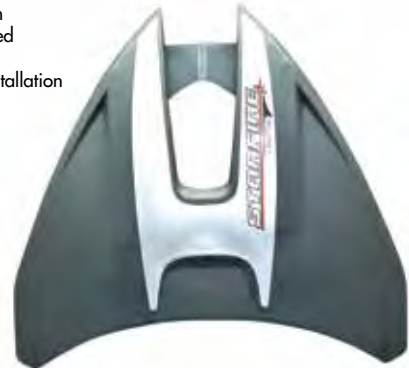
**Part No.**

A23-STARFIRE-1 - Black
 A23-STARFIRE-3 - Grey

Stingray Classic Stealth 2

13

NO-DRILL installation
 Dual-angle wings transition lift to speed
 Wide wings result in greater stabilization
 New robust, stainless-steel
 components

**Part No.**

A23-STEALTH-2-1 - Black
 A23-STEALTH-2-3 - Grey

Stingray Classic XR III, Junior

14

NO-DRILL installation
 Increased thrust enhancement
 Improved top speed
 Greater fuel efficiency
 Vision-3 enhanced styling

**Part No.**

A23-JR-XRIII-1 - Black
 A23-JR-XRIII-3 - Grey

Stingray Classic XR III, Senior

15

NO-DRILL installation
 Increased thrust enhancement
 Improved top speed
 Greater fuel efficiency
 Vision-3 enhanced styling

**Part No.**

A23-SR-XRIII-1 - Black
 A23-SR-XRIII-3 - Grey

Aqualift Hydrofoil

16

**Part No.**

A23-70088 - 60Hp B/F and up
 A23-C88061 - 60Hp and smaller
 A23-C88062 - Black

Hydrofoil Stingray Stinger 1

17

**Part No.**

A23-STINGER 1

Hydro Tail Performance Set

18

**Part No.**

A23-HYD-1-DP

Nauticus Smart Tabs

J1

Boat Type:
Large ribs, day cruisers, deck boats,
rescue boats and day cruisers.

Boat Length:
6.4 - 7.7 Meters

Motor Type:
Two Stroke Outboard,
Four Stroke Outboard and
8 Cyl Inboard.

Motor Size:
200Hp to 250Hp

Part No.
A37-SX10512-90-DB - 10.5" x 12" Plate 90LB Actuator



Nauticus Smart Tabs

J2

Boat Type:
Ribs, flats and bay, bow riders,
fishing boats and ski boats.

Boat Length:
3.7 - 4.9 Meters

Motor Type:
Two Stroke Outboard and Four
Stroke Outboard

Motor Size:
40Hp - 50Hp Four Stroke
50Hp - 80Hp Two Stroke

Part No.
A37-ST980-40 - Stainless Steel 9" x 8" Plate 40LB Actuator



Nauticus Smart Tabs

J3

Boat Type:
Ribs, flats and bay, bow riders,
fishing boats and ski boats.

Boat Length:
3.7 - 4.9 Meters

Motor Type:
Two Stroke Outboard and
Four Stroke Outboard

Motor Size:
40Hp - 50Hp Four Stroke
50Hp - 80Hp Two Stroke

Part No.
A37-SX9510-40-BL - 9.5" x 10" Plate 40LB Actuator



Nauticus Smart Tabs

J4

Boat Type:
Ribs, flats and bay, bow riders, day
cruisers, fishing, ski boats and deck
boats.

Boat Length:
4.6 - 5.5 Meters

Motor Type:
Two Stroke Outboard and Four
Stroke Outboard

Motor Size:
60Hp - 135Hp Four Stroke
90Hp - 150Hp Two Stroke

Part No.
A37-ST12960-60 - Stainless Steel 12" x 9" Plate 60LB Actuator



Nauticus Smart Tabs

J5

Boat Type:
Ribs, flats and bay, bow riders, day
cruisers, fishing, ski boats and deck
boats.

Boat Length:
4.6 - 5.2 Meters

Motor Type:
Four Stroke Outboard

Motor Size:
60Hp - 135Hp Four Stroke
90Hp - 150Hp Two Stroke

Part No.
A37-SX9510-60-BL - 9.5" x 10" Plate 60LB Actuator



Nauticus Smart Tabs

J6

Boat Type:
Ribs, flats and bay, bow riders, day
cruisers, fishing, ski boats and deck
boats.

Boat Length:
5.5 - 6.7 Meters

Motor Type:
Two Stroke Outboard and
Four Stroke Outboard

Motor Size:
150Hp - 240Hp Four Stroke
or Two Stroke

Part No.
A37-SX9510-80-BL - 9.5" x 10" Plate 80LB Actuator



Nauticus Smart Tabs

J7

Boat Type:
Inboard and Outboard Boats

Boat Length:
5.5 - 6.7 Meters

Motor Type:
Inboard and Outboard

Motor Size:
8 Cylinder

Part No.
A37-ST12990-80 - Stainless Steel 12" x 9" Plate 80LB Actuator





HYDRAULIC STEERING

OBKIT5 Front Mount System

A1

(Turns Ho/Ho 4.5) - 216 FM Cylinder. This cylinder is capable of handling single engine installations up to 300HP or multiple engine installations up to 600HP. It requires a small amount of tolerance (615mm).

Dimension: 737.50 full RAM end stroke length. Each complete kit contains Hydrive hydraulic fluid; 2 x brass fittings, 1 x 12m length of hydraulic tubing, 1 x plastic bleed bottle, 1 x Hydrive Helm and a Hydrive Ram.



Part No.
A24-4006

Prokit Compact Front Mount System

A2

(Turns Ho/Ho 4) (Bull Horn)

For small inboard vessels, jet units and outboards up to twin 150HP CXL or 235 HP single. The complete PROKIT is the ideal choice using the 212BH cylinder. Each complete kit contains Hydrive hydraulic fluid, 2 x brass fitting, 1 x 12m length of hydraulic tubing, 1 x plastic bleed bottle, 1 x Hydrive Helm and a Hydrive Bull Horn Ram (19" - 492mm).



Part No.
A24-4007

Obkit1 Front Mount System

A3

(Turns Ho/Ho 5) (Bull Horn) - 211 BH

It is capable of handling single and multiple engine installations (up to 1200HP). Requires only a small amount of clearance (615mm).

Each complete kit contains Hydrive hydraulic fluid; 2 x brass fittings, 1 x 12m length of hydraulic tubing, 1 x plastic bleed bottle, 1 x Hydrive Helm and a Hydrive Bull Horn Ram (26" = 660mm).



Part No.
A24-4008 - Std

Sportkit Compact Side Mount System

A4

(Turns Ho/Ho 3) For small inboard vessels, jet units and outboards up to twin 150HP CSL or 235HP single. The complete SPORTKIT is the ideal choice using the 212T Sport cylinder. Giving direct control for most boats up to 8 metres, this cylinder is made from the finest anodised aluminium and stainless steel.



Part No.
A244009

Obkit3 Side Mount System

A5

(Turns Ho/Ho 5) The side mount 210TSE (unbalanced) can handle the same horsepower as the power Bull Horn cylinder (up to 225 HP CXL), but it is simpler and cheaper to install. The only restriction to fitting them is the side clearance requirements in the engine well.



Part No.
A24-4010

COMKIT-1 Bullhorn O/B Kit

A6



Part No.
A24-COMKIT-1- up to single 200Hp or 400Hp counter rotation

COMKIT-1 Pro

A7



Part No.
A24-COMKIT-PRO- up to 300Hp single and 600Hp counter rotation

COMKIT-5 Front Mount O/B Kit

A8



Part No.
A24-COMKIT-5- up to 200Hp single

COMKIT-5 Pro

B1



Part No.
A24-COMKIT5-Pro - up to 200Hp commercial use

COMKIT-Sport Side Mount Outboard Kit

B2



Part No.
A24-COMKIT-Sport - up to 135Hp single and 250Hp counter rotation

COMKIT6 Bullhorn OB Kit

B3



Part No.
A24-COMKIT-6 - single outboard up to 150Hp

Obkit Double Ended Transom Mount System 210DE

B4

(Turns Ho/Ho 6)
The perfect steering solution for narrow engine well installations as it offers minimum space wastage and stationary hoses during operation. The tie bars need to be custom made to fit, and provide universal movement on each end to allow independent tilting of the motors.



Part No.
A24-4011

102N8 Helm

B5

2.00cu ins (35cc)/rev
Meets ABYC requirements Optical 20 degree Bezel Kit alters angle of wheel to dash.



Part No.
A24-4000 - 28cc
A24-4001 - 35cc

401N8 Helm

B6

Front Mount Helm now standard on all kits.
Displaces 28cc 3/8"



Part No.
A24-101N8-FM

402 Helm Pump 3/8" Nylon

B7



Part No.
A24-402N8

Tool Kit Helm

B8



Part No.
A24-SERVKIT 401

Wedge 20° Helm Wedge 401

C1



Part No.
A24-4050
A24-WEDGE-401

211BH Bull Horn

C2

Cylinder 135cc



Part No.
A24-4140

210BHN8 Front Mount Cylinder

C3

Capable of handling single or multiple outboard engine installations up to 1200Hp combined. This heavy duty version of the 211BH is the ideal choice for high performance or heavy duty commercial use.



Part No.
A24-4141

216FM New Front Mount

C4

Cylinder 137cc



Part No.
A24-4142

212TN8 Compact Side Mount

C5

Cylinder 78cc



Part No.
A24-4149

210TN8 Side Mount Cylinder

C6

Cylinder 154cc



Part No.
A24-4150
A24-4151 - Balanced

210N8 Bracket Mount Cylinder for Inboards

C7

(Turns Ho/Ho 5.5)

This bracket-mounted 210TNE (Balanced) cylinder combined in this kit with the Admiral 101 Helm provides a useful installation option for inboard engines.



Part No.
A24-4160 - Outboard
A24-4161 - Inboard

211BHN8 Bullhorn Cylinder

C8



Part No.
A24-4170

411BHN8 Bullhorn Cylinder D1



Part No.
A24-4180

511BH Cylinder D2



Part No.
A24-511BH

Hose D3



Part No.
A24-4500 - 15m Hose
A24-4501 - 100m 3/8" Nylon Hose (Solid per m)

Bypass Valve for Liquid Tie Bar D4



Part No.
A24-4506

Ultra 15 Hydrive Fluid (per litre) D5



Part No.
A24-4601

Rear Mount Kit D6



Part No.
A24-REAR - Mount

Power Bleed Kit D7



NO IMAGE AVAILABLE

Part No.
A24-PBK-12

Steering Cable 1.5m D8



Part No.
A24-PC7120

Admiral Heavy Duty Boat Steering

E1



Part No.
A24-3022 - 331C - Lock Valve (Auto Pilot)

Admiral Heavy Duty Steering Cylinders

E2

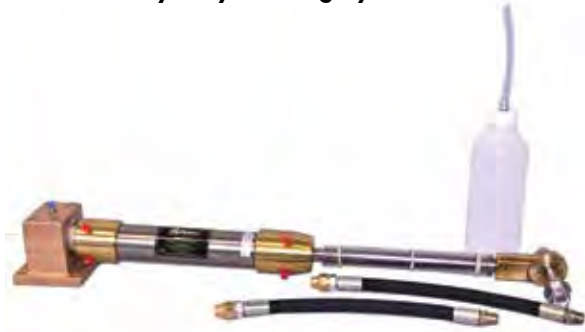

Part No.
A24-HD175-10 - Slave Cylinder

Dual Cylinder Hose Kit

E3



Part No.
A24-PBK-DCH

Tee Piece OB Cycle

E4



Part No.
A24-4055

Helm 501N8

E5



Part No.
A24-501N8

Cylinder Complete 512BH

E6



Part No.
A24-512BHN8

Bullhorn 411BH

E7



Part No.
A24-BH-6165

Bullhorn Pro 212BH

E8



Part No.
A24-BH-6376A

Bleeder Tees 1/2" x 1/4"

F1



Part No.
A24-BL-10188A

Boot Hydrive Helm

F2



Part No.
A24-BOOT

Seal Kits

F3

Part No.

- A24-SK101 - Seal Kit 101 Helm
- A24-SK150 - Service Kit For 150 Cylinder.
- A24-SK175 - Seal Kit
- A24-SK201 - Seal Kit for 201 and 202 Helm
- A24-SK210 - Seal Kit 210 Cylinder
- A24-SK210BH - Seal Kit 210 BH Front Mount Cylinder
- A24-SK210T - Seal Kit 210T Cylinder
- A24-SK211BH - Seal Kit Complete 211BH
- A24-SK212 - Seal Kit 212 Cylinder
- A24-SK212PRO - Seal Kit
- A24-SK212T - Seal Kit
- A24-SK213 - Seal Kit
- A24-SK216FM - Seal Kit 216 Front Mount
- A24-SK401 - Seal Kit 401/402/501 Helm Unit
- A24-SK411BH - Seal Kit 411 BH Cylinder



Nominal Dimensions in Mid Stroke Position

Model	HD-150-9	HD150-12	HD175-10	HD175-12	HD200-12	HD200-15	HD250-12	HD250-15
Stroke	230	305	254	305	305	380	305	380
A	557	635	583	685	685	835	685	835
B	139	215	165	190	215	290	215	290
C	743	898	794	900	900	975	900	975
D	52	52	52	52	52	52	52	52
E	60	60	60	60	60	60	60	60
F	102.5	102.5	102.5	102.5	102.5	102.5	102.5	102.5
G	106	106	106	106	106	106	106	106
H	218	265	240	265	265	340	265	340
I	375	450	400	450	450	525	450	525
J	53	53	53	53	53	53	53	53
K	106	106	106	106	106	106	106	106

Some Possible Steering Torque Combinations for Single and Dual Cylinder Systems

Cyl/Model	Torque Kgm	Volume CC's	301 Helm	304 Helm	305 Helm
150-9	107	172	4.9	4	2
150-9 x 2	214	344	9.8	8	4
150-12	143	229	6.5	5.3	2.7
175-10	185	296	8.4	6.9	3.4
175-10 x 2	370	592	n/a	13.8	6.8
175-12	221	355	10.1	8.2	4.1
175-12 x 2	442	705	n/a	n/a	8.2
200-12	289	463	13.2	10.8	5.4
200-12 x 2	578	926	n/a	n/a	10.8
200-15	362	579	n/a	13.5	6.7
250-12	506	811	n/a	n/a	9.4
250-15	633	1014	n/a	n/a	11.8
250-12 x 2	1012	1622	n/a	n/a	18.8
250-15 x 2	1266	2028	n/a	n/a	23.6

Seafirst Hydraulic Steering

G1

Front Help Pump 18cc, front mount outboard cylinder up to 100HP

Hydraulic oil 1 liter x 2 bottles hydraulic hose 1/4, 6 meters x 2 pcs, help pump fittings, help pump hardware kit



Part No.
A24-M0100H-18

Seafirst Hydraulic Steering

G2

Front Help Pump 18cc, front mount outboard cylinder up to 150HP

Hydraulic oil 1 liter x 2 bottles hydraulic hose 1/4, 6 meters x 2 pcs, help pump fittings, help pump hardware kit



Part No.
A24-M0150H-R1-18

Seafirst Hydraulic Steering

G3

Front Help Pump 25cc, front mount outboard cylinder up to 350HP

Hydraulic oil 1 liter x 2 bottles hydraulic hose 1/4, 6 meters x 2 pcs, help pump fittings, help pump hardware kit



Part No.
A24-M0350H-R1-30

Seafirst Hydraulic Steering

G4

Front Help Pump 25cc, front mount outboard cylinder up to 350HP

Hydraulic oil 1 liter x 2 bottles hydraulic hose 1/4, 6 meters x 2 pcs, help pump fittings, help pump hardware kit.

Twin Single Cyl up to 600HP



Part No.
A24-M0350HT1-R1-2

Seafirst Hydraulic Steering

G5

Front Help Pump 25cc, front mount outboard cylinder up to 350HP

Hydraulic oil 1 liter x 2 bottles hydraulic hose 1/4, 6 meters x 2 pcs, help pump fittings, help pump hardware kit.

Twin Dual Cyl up to 700HP



Part No.
A24-M0350HT2-R1-2



CONTROL BOXES & CABLES

Basic Quicksilver Control Box Manual

A1

10-40Hp Manual



Part No.
13896

Dual Control Box Kit

A2

For use with side mount control boxes



Part No.
16909A2

Adapter Kits

A3



Part No.
A25-2100 - Adapter Kit OMC Engine
A25-2101 - Cable Adapter Kit Control Box End

Connecting Kit Control Box End

A4

For Mercury - 2 Cables



Part No.
82779-
A25-30107

Control Box Side Mount (No Trim)

A5



Part No.
881170A12 - With Amp Connector
881170A16 - With Warning Horn - 14 Pin

Remote Control

A6



Part No.
881170A9 - International Models

Connecting Kits Engine End

A7



Part No.
64-892790A01 - For 1 Cable
A25-30190 - Set (Pair)

Control Systems

A8



Part No.
A25-308601 - Single Engine Control
A25-308602 - Twin Engine Control



Control System Box B1

Part No.
 A25-L5311228 - Black
 A25-L5374228 - White

RC Single O/B Trim B2

Part No.
 8M0059686

RC Dual O/B Trim 4500 B3

Part No.
 8M0075245

Control Cable Gen I Premium B4
QUICKSILVER

Part No.
 8M0052487 - 8ft
 8M0052489 - 10ft
 8M0052490 - 11ft
 8M0052491 - 12ft
 8M0052494 - 15ft
 8M0052496 - 17ft
 8M0052497 - 18ft
 8M0052501 - 22ft

Control Cable B5
OMC

Part No.	A25-2510 - 10ft Hd.
A25-2210 - 10ft Std.	A25-2511 - 11ft Hd.
A25-2212 - 12ft Std.	A25-2512 - 12ft Hd.
A25-2213 - 13ft Std.	A25-2513 - 13ft Hd.
A25-2214 - 14ft Std.	A25-2514 - 14ft Hd.
A25-2215 - 15ft Std.	A25-2515 - 15ft Hd.
A25-2216 - 16ft Std.	A25-2516 - 16ft Hd.
A25-2217 - 17ft Std.	A25-2517 - 17ft Hd.
A25-2218 - 18ft Std.	A25-2518 - 18ft Hd.
A25-2219 - 19ft Std.	A25-2519 - 19ft Hd.
A25-2220 - 20ft Std.	A25-2520 - 20ft Hd.
A25-2221 - 21ft Std.	A25-2521 - 21ft Hd.
A25-2222 - 22ft Std.	A25-2522 - 22ft Hd.



Control Cable Gen II Premium

C1



Part No.

- | | |
|------------------|------------------|
| 8M0052682 - 11Ft | 8M0085973 - 12Ft |
| 8M0052684 - 13Ft | 8M0085975 - 14Ft |
| 8M0052686 - 15Ft | 8M0085978 - 17Ft |
| 8M0052687 - 16Ft | 8M0085979 - 18Ft |
| 8M0052692 - 21Ft | 8M0085980 - 19Ft |
| | 8M0085981 - 20Ft |

Control Cable Gen II

C2



Part No.

- | | |
|-----------------|-----------------|
| A25-2410 - 9ft | |
| A25-2411 - 10ft | |
| A25-2412 - 11ft | |
| A25-2413 - 12ft | |
| A25-2414 - 13ft | |
| A25-2415 - 14ft | |
| A25-2416 - 15ft | |
| A25-2417 - 16ft | |
| A25-2418 - 17ft | |
| A25-2419 - 18ft | |
| A25-2420 - 19ft | |
| A25-2421 - 20ft | |
| A25-2422 - 21ft | A25-2425 - 24ft |
| A25-2423 - 22ft | A25-2426 - 25ft |
| A25-2424 - 23ft | A25-2428 - 28ft |

**Control Shift Cable S/Steel Standard Duty 33C
Light duty**

C3



Part No.

- | | |
|-----------------|-----------------|
| A25-2106 - 6ft | |
| A25-2107 - 7ft | |
| A25-2108 - 8ft | |
| A25-2109 - 9ft | |
| A25-2110 - 10ft | A25-2121 - 21ft |
| A25-2111 - 11ft | A25-2122 - 22ft |
| A25-2112 - 12ft | A25-2123 - 23ft |
| A25-2113 - 13ft | A25-2124 - 24ft |
| A25-2114 - 14ft | A25-2125 - 25ft |
| A25-2115 - 15ft | A25-2126 - 26ft |
| A25-2116 - 16ft | A25-2127 - 27ft |
| A25-2117 - 17ft | A25-2128 - 28ft |
| A25-2118 - 18ft | A25-2130 - 30ft |
| A25-2119 - 19ft | A25-2131 - 31ft |
| A25-2120 - 20ft | A25-2133 - 33ft |
| | A25-2137 - 37ft |

Control Shift Cable S/Steel Heavy Duty 33C

C4



Part No.

- | | |
|-----------------|-----------------|
| A25-2310 - 10ft | |
| A25-2311 - 11ft | |
| A25-2312 - 12ft | |
| A25-2313 - 13ft | |
| A25-2314 - 14ft | |
| A25-2315 - 15ft | |
| A25-2316 - 16ft | |
| A25-2317 - 17ft | |
| A25-2318 - 18ft | |
| A25-2319 - 19ft | |
| A25-2320 - 20ft | |
| A25-2321 - 21ft | |
| A25-2322 - 22ft | |
| A25-2323 - 23ft | |
| A25-2324 - 24ft | |
| A25-2325 - 25ft | |
| | A25-2326 - 26ft |
| | A25-2327 - 27ft |
| | A25-2328 - 28ft |
| | A25-2329 - 29ft |
| | A25-2330 - 30ft |
| | A25-2331 - 31ft |
| | A25-2332 - 32ft |
| | A25-2333 - 33ft |
| | A25-2334 - 34ft |
| | A25-2335 - 35ft |
| | A25-2336 - 36ft |
| | A25-2337 - 37ft |
| | A25-2338 - 38ft |
| | A25-2339 - 39ft |
| | A25-2340 - 40ft |

Pinnacle Mercury Gen I



Part No.

- A25-2605 - 5ft
- A25-2606 - 6ft
- A25-2607 - 7ft
- A25-2608 - 8ft
- A25-2609 - 9ft
- A25-2610 - 10ft
- A25-2611 - 11ft
- A25-2612 - 12ft
- A25-2613 - 13ft
- A25-2614 - 14ft
- A25-2615 - 15ft
- A25-2616 - 16ft
- A25-2617 - 17ft
- A25-2618 - 18ft
- A25-2619 - 19ft
- A25-2620 - 20ft
- A25-2621 - 21ft
- A25-2622 - 22ft
- A25-2623 - 23ft
- A25-2624 - 24ft
- A25-2625 - 25ft
- A25-2626 - 26ft
- A25-2627 - 27ft
- A25-2628 - 28ft
- A25-2629 - 29ft
- A25-2630 - 30ft



MECHANICAL STEERING

Bracket Dual Mount

A1



Part No.

17729A1 - Quicksilver (Black)
A255-5017 - S/S Bracket

Tie Bars (Standard)

A2



Part No.

A255-5000 - Tie Bar S/S 500mm X 12mm (Rod & Nut)
A255-5002 - Tie Bar S/S 600mm X 12mm (Rod & Nut)
A255-5003 - Tie Bar S/S 700mm X 12mm (Rod & Nut)
A255-5004 - Tie Bar S/S 800mm X 12mm (Rod & Nut)
A255-5015 - Tie Bar S/S 1100mm X 12mm (Rod & Nut)
A255-5016 - Tie Bar S/S 1300mm X 12mm (Rod & Nut)

Joints (Tie Bar End)

A3



Part No.

A255-5001 - Rose Joint (Brass/Chrome)
A255-5009 - Ball Joint (Tie Bar End)

Emergency Steering

A4



Part No.

A255-5013 - Mercury
A255-5014 - Universal

Splash Well Mount Steering Bracket

A5



Part No.

A255-1022

Transom Mount Steering Bracket

A6



Part No.

A255-1023

Rotary Helm Hardware Kit

A7



Part No.

A255-370002
A255-370004

Rotary Single Tilt Helm

A8



Part No.

A255-370970

Tilt Helm Pack B1

Part No.
A25S-370990

Steering Helm B2
Steering Head only

Part No.
A25S-4000 - Single
A25S-4001 - Dual

90 Degree Tilt Base B3

Part No.
A25S-370981

Bezels B4

Part No.
A25S-4012 - Replacement Hardware Kit
A25S-4013 - 3000 Degree Black Bezel
A25S-4014 - 2900 20 Degree Black Bezel
A25S-9014 - 20 Degree Rotary Steering Head On

Rotary Steering Cable B5

Part No.
A25S-7008 - 8"
A25S-7009 - 9"
A25S-7010 - 10"
A25S-7011 - 11"
A25S-7012 - 12"
A25S-7013 - 13"
A25S-7014 - 14"
A25S-7015 - 15"
A25S-7016 - 16"
A25S-7017 - 17"
A25S-7018 - 18"
A25S-7019 - 19"
A25S-7020 - 20"
A25S-7021 - 21"
A25S-7022 - 22"
A25S-7024 - 24"

Rotary Steering System Kit B6

Part No.
A25S-7709 - 9"
A25S-7710 - 10"
A25S-7711 - 11"
A25S-7712 - 12"
A25S-7713 - 13"
A25S-7714 - 14"
A25S-7715 - 15"
A25S-7716 - 16"
A25S-7717 - 17"
A25S-7718 - 18"
A25S-7719 - 19"
A25S-7720 - 20"
A25S-7721 - 21"
A25S-7722 - 22"
A25S-7723 - 23"
A25S-7724 - 24"
A25S-7725 - 25"

S/S Rotary Steering Cable B7

Part No.
A25S-8008 - 8ft
A25S-8010 - 10ft
A25S-8011 - 11ft
A25S-8012 - 12ft
A25S-8013 - 13ft
A25S-8014 - 14ft
A25S-8015 - 15ft
A25S-8016 - 16ft
A25S-8017 - 17ft
A25S-8018 - 18ft
A25S-8019 - 19ft
A25S-8020 - 20ft
A25S-8024 - 24ft

S/S Rotary Steering System / Complete B8

Part No.
A25S-8810 - 10ft
A25S-8811 - 11ft
A25S-8812 - 12ft
A25S-8813 - 13ft
A25S-8814 - 14ft
A25S-8815 - 15ft
A25S-8816 - 16ft
A25S-8817 - 17ft
A25S-8818 - 18ft
A25S-8819 - 19ft
A25S-8820 - 20ft

ZTS Rotary Helm

C1



Part No.
A255-9000 - S/S

**Non Feed Back Complete System
Stainless Cable**

C2

Part No.

- A255-9907 - 7ft
- A255-9908 - 8ft
- A255-9909 - 9ft
- A255-9910 - 10ft
- A255-9911 - 11ft
- A255-9912 - 12ft
- A255-9913 - 13ft
- A255-9914 - 14ft
- A255-9915 - 15ft
- A255-9916 - 16ft
- A255-9917 - 17ft
- A255-9918 - 18ft
- A255-9919 - 19ft
- A255-9920 - 20ft
- A255-9921 - 21ft



Steering Cable Adaptor

C3



Part No.
A255-370983 - Quick connect to Nut Type

Extension Handle

C4

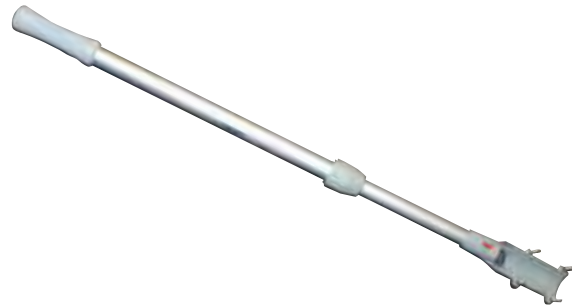

Part No.
A255-N4130120

Steering Link Arm

C5



Part No.
A255-370621



INSTRUMENTATION

Flagship Series White

Speedometer

A1



Part No.

79-895285A21 - Flagship Speedo 45Mph
79-895285A23 - Flagship Speedo 65Mph
79-895285A24 - Flagship Speedo 80Mph

Battery Gauge

A2



Part No.

79-895286A21 - Flagship Battery Gauge

Fuel Gauge

A3



Part No.

79-895291A21 - Flagship Fuel Gauge only

Hour Meter

A4



Part No.

79-895295A21 - Flagship Hour Meter

Tachometer

A5



Part No.

79-895283A23 - Flagship Tacho 6000 Rpm
79-895283A25 - Flagship Tacho 7000 Rpm
79-895283A26 - Flagship Tacho 8000 Rpm

Trim Gauge

A6



Part No.

79-895292A21 - Flagship Power Trim Gauge

Water Temperature Gauge

A7



Part No.

79-895287A21 - Mercruiser V6
79-895287A22 - Various

Water Pressure Gauge

A8



Part No.

79-895288A21 - Flagship Water Pressure Gauge Kit 15PSI includes tubing
79-895288A22 - Flagship Water Pressure Gauge 15PSI
79-895288A23 - Flagship Water Pressure Gauge Kit 30PSI includes tubing
79-895288A24 - Flagship Water Pressure Gauge 30PSI
79-895288A25 - Flagship Water Pressure Gauge Kit 40PSI includes tubing
79-895288A26 - Flagship Water Pressure Gauge 40PSI

Flagship Series White

Volt Meter B1



Part No.
79-895286A21

Oil Pressure Gauge B2



Part No.
79-895289A21

Oil Level Kit B3



Part No.
79-895290A21

Flagship Series Black

Speedometer

C1



Part No.

79-895285A01 - Flagship Speedo 45Mph
 79-895285A03 - Flagship Speedo 65Mph
 79-895285A04 - Flagship Speedo 80Mph

Tachometer

C2



Part No.

79-895283A03 - Flagship Tacho 6000 Rpm
 79-895283A05 - Flagship Tacho 7000 Rpm
 79-895283A06 - Flagship Tacho 8000 Rpm

Trim Gauge

C3



Part No.

79-895292A01 - Flagship Power Trim Gauge

Fuel Gauge

C4



Part No.

79-895291A01 - Flagship Fuel Gauge Only
 851052Q - Flagship Fuel Sender Kit

Water Pressure Gauge

C5



Part No.

79-895288A01 - Flagship Water Pressure Kit 1.5 PSI includes tubing
 79-895288A02 - Flagship Water Pressure 1.5 PSI
 79-895288A03 - Flagship Water Pressure Kit 30 PSI includes tubing
 79-895288A04 - Flagship Water Pressure 30 PSI
 79-895288A05 - Flagship Water Pressure Kit 40 PSI includes tubing
 79-895288A06 - Flagship Water Pressure 40 PSI

Water Temperature Gauge

C6



Part No.

79-895287A02 - Flagship Water Temperature Gauge
 79-895287A01 - Water Temperature Gauge (Black face and black bezel)

Oil Pressure Gauge

C7



Part No.

79-895289A01 - Flagship Oil Pressure Gauge
 79-895289A02 - Flagship Oil Pressure Gauge

Clock

C8



Part No.

79-895297A01 - Flagship Clock

Flagship Series Black

Volt Meter

D1



Part No.
79-895286A01 - Flagship Volt Meter

Oil Level Gauge Kit

D2



Part No.
79-895290A01 - Flagship Oil Level Gauge Kit

Hour / Cruise Log

D3



Part No.
79-895295A01 - Flagship Hour / Cruise Log

Instrument Set MCM / Inboard

D4



Part No.
79-895283A01 - MCM Inboard

Flagship Series White Face with Chrome Bezel

QUICKSILVER

Speedometer

E1



Part No.

79-895285A41 - Flagship Speedo 45Mph
 79-895285A43 - Flagship Speedo 65Mph
 79-895285A44 - Flagship Speedo 80Mph
 79-895285A46 - Flagship Speedo 100Mph

Tachometer

E2



Part No.

79-895283A43 - Flagship Tacho 6000 Rpm
 79-895283A45 - Flagship Tacho 7000 Rpm
 79-895283A46 - Flagship Tacho 8000 Rpm

Trim Gauge

E3



Part No.

79-895292A41 - Flagship Power Trim Gauge

Fuel Gauge

E4



Part No.

79-895291A41 - Flagship Fuel Gauge Only

Water Temperature Gauge

E5



Part No.

79-895287A41 - Flagship Water Temperature Gauge 100° to 240°
 79-895287A42 - Flagship Water Temperature Gauge 60° to 200°

Water Pressure Gauge

E6



Part No.

79-895288A41 - Flagship Water Pressure Kit 1.5 PSI includes tubing
 79-895288A42 - Flagship Water Pressure 1.5 PSI
 79-895288A43 - Flagship Water Pressure Kit 30 PSI includes tubing
 79-895288A44 - Flagship Water Pressure 30 PSI
 79-895288A45 - Flagship Water Pressure Kit 40 PSI includes tubing

Oil Pressure Gauge

E7



Part No.

79-895289A41 - Flagship Oil Pressure Gauge

Oil Level Gauge Kit

E8



Part No.

79-895290A41 - Flagship Oil Level Gauge Kit

Flagship Series White Face with Chrome Bezel



Dual Engine Synchronizer F1



Part No.
79-895294A41 - Flagship Dual Engine Synchronizer

Cruizelog Gauge F2



Part No.
79-895295A41 - Flagship Cruizelog Gauge

Volt Meter F3



Part No.
79-895864A41 - Flagship Volt Meter

Flagship Series Miscellaneous

QUICKSILVER

Carbon Fibre Display

G1



Part No.
A27-DY0007 - Carbon Fibre Display

Depthsounder Dual Temperature

G2



Part No.
A27-DS0103 - Depthsounder Dual Temperature

Hole Cover Kit

G3



Part No.
79-79889A1 - Hole Cover Kit (54mm)

Installation Hardware

G4



Part No.
32-5495053 - Speedo Tubing 16m length
32-5495025 - Speedo Tubing 25'
77409A1 - Speedo Pilot and mount only
77409B1 - Speedo Pick-up and Tube Kit

Service Monitor / Tacho

G5



Part No.
79-8080399 - Service Monitor / Tacho

Star Gazer Three Event

G6



Part No.
A27-SG101 - Star Gazer Three Event

Star Gazer Wake Edition

G7



Part No.
A27-SG100 - Star Gazer Wake Edition

Universal Pitot

G8



Part No.
77409A1 - Universal Pitot only - Black
77409B1 - Universal Pitot and tube - Black

Flagship Series Miscellaneous**QUICKSILVER**[®]**Depth Gauge**

Transmounted / Inside hole mounted transducer

H1

**Part No.**

79-879292A01- White

Depth Gauge

Transmounted / Inside hole mounted transducer

H2

**Part No.**

79-879292A02- Flagship Depth Gauge - Black

NOTES



STEERING WHEELS

S/S Steering Wheel with finger grips and knob A1



Part No.
A28-73066-01 - dia: 13 - 1/2" 3/4" shaft
A28-73066-02 - dia: 15 - 1/2" 3/4" shaft



Corse B/S Steering Wheel A2

This wheel is a great value with soft grip and great looks. This Steering Wheel is a three-spoke design with a soft black grip and silver spokes.

Wheel Dia.: 13.8" (350mm)
 Standard .75" (19mm) taper



Part No.
67-892762A01/ A28-9018 - Black Centre

QS 3-Spoke Steering Wheel / Steering Wheel Hub A3

This wheel is great value with soft grip and great looks. This steering Wheel is a three-spoke design with a black grip and black spokes. Thermoplastic antishock material.

Wheel Dia.:
 13.8" (350mm)
 Standard .75" (19mm) taper



Part No.
67-892762A05/ A28-9020



S/S Steering Wheel AISI 304 5 Spoke A4

Wheel Dia.:
 15"



Part No.
A28-000715



S/S 304 Steering Wheel W/Black Sleeve and Wave Curve A5

Wheel Dia.:
 15 - 1/2" or
 13 - 1/2", 25°



Part No.
A25S-73064-01B
A25S-73064-02B



S/S Wheel W/Backlite Cap A6

Wheel Dia.:
 13 - 1/2" O.D. 7/8" Tube



Part No.
A25S-73061

Oxnard Steering Wheel A7



Part No.
A28-MF34521 - Black

Huntington Steering Wheel A8



Part No.
A28-MF3011

Pismo Black

B1



Part No.
A28-MF335225

Coronado Steering Wheel

B2



Part No.
A28-MF3511

Redondo Steering Wheel

B3



Part No.
A28-MF3703

Avalon Steering Wheel

B4



Part No.
A28-MF3561

Morrobay Steering Wheel

B5



Part No.
A28-MF4511

Monterey Steering Wheel

B6



Part No.
A28-MF4512

Hermosa Steering Wheel

B7



Part No.
A28-MF33581



TROLLING MOTORS

Xi5 Wireless Trolling Motor

A1

Fresh Water Bow Mount 12V Xi5**Specifications**

Thrust: 55 Lbs
 Voltage: 12V
 Shaft length: 45", 48", 54"
 Control: Digital
 Wireless Pedal
 2 Blade Weedless Prop

Part No. A29-Xi5-55W 45SNR GPS
 A29-Xi5-55FW8
 A29-Xi5-55FW54

A29-Xi5-55FW 54SNR GPS
 A29-Xi5-55SW 54

Fresh Water Bow Mount 24V Xi5**Specifications**

Thrust: 80 Lbs
 Voltage: 24V
 Shaft length: 45", 54", 60"
 Control: Digital
 Wireless Pedal
 2 Blade Weedless Prop

Part No. A29-Xi5 80FW 45
 A29-Xi5 80FW 45SNR GPS
 A29-Xi5-80FW 54

A29-Xi5-80FW 54SNR
 A29-Xi5-80FW 54SNR GPS

Fresh Water Bow Mount 36V Xi5**Specifications**

Thrust: 105 Lbs
 Voltage: 12V
 Shaft length: 54", 60"
 Control: Digital
 Wireless Pedal
 2 Blade Weedless Prop

Part No. A29-Xi5-105FW 54SNR GPS

**Xi5 Wireless Trolling Motor**

A2

Salt Water Bow Mount 24V Xi5**Specifications**

Thrust: 80 Lbs
 Voltage: 12V
 Shaft length: 48", 60"
 Control: Digital
 Wireless Pedal
 2 Blade Safari

Part No.
 A29-Xi5-80SW 48

Salt Water Bow Mount 24V Xi5**Specifications**

Thrust: 108 Lbs
 Voltage: 36V
 Shaft length: 60"
 Wireless Pedal Optional Extra

Part No.
 A29-Xi510SW 60 GPS

Salt Water Bow Mount 24V Xi5**Specifications**

Thrust: 80 Lbs
 Voltage: 12V
 Shaft length: 48", 60"
 Control: Digital
 Wireless Pedal
 2 Blade Safari

Part No.
 A29-Xi5-80SW 60 GPS





X5 Trolling Motor

B1

Fresh Water, Foot-control Bow Mount 36V X5

Specifications

Thrust: 105lbs
Voltage: 36V
Shaft Length: 45"
Control: Digital Variable
Dual Cable / VRS
Prop: 2 Blade Safari

Part No. A29-X5-105FW 45 36V

Fresh Water, Foot-control Bow Mount 24V X5

Specifications

Thrust: 80lbs
Voltage: 24V
Shaft Length: 45"
Control: Digital Variable
Dual Cable / VRS
Prop: 2 Blade Safari

Part No. A29-X5-80FW 45 24V

Fresh Water, Foot-control Bow Mount 12V X5

Specifications

Thrust: 55lbs
Voltage: 12V
Shaft Length: 45"
Control: Digital Variable
Dual Cable / VRS
Prop: 2 Blade Safari

Part No. A29-X5-55FW 45 12V

XI3 Wireless Trolling Motor

B2

Fresh Water Bow Mount Xi3

Specifications

Thrust: 55 Lbs
Voltage: 12V
Shaft length: 54"
Control: Digital Variable
Steering: Wireless Remote
Battery Meter

Part No.

A29-940700020
A29-XI3-55FW 54" GPS
A29-XI3-55FW 54" SNR GPS

Specifications

Thrust: 70 Lbs
Voltage: 24V
Shaft length: 54"
Control: Digital Variable
Steering: Wireless Remote
Battery Meter

Part No.

A29-940700030
A29-XI3-70FW 54" GPS
A29-XI3-70FW 54" SNR/GPS
A29-XI3-70FW-60" SNR/GPS

XI3 Wireless Trolling Motor

B3

Salt Water Bow Mount Xi3

Specifications

Thrust: 55 Lbs
Voltage: 12V
Shaft length: 54"
Control: Digital Variable
Steering: Wireless Remote
Battery Meter

Part No. Special Order

Specifications

Thrust: 70 Lbs
Voltage: 24V
Shaft length: 54"
Control: Digital Variable
Steering: Wireless Remote
Battery Meter

Part No. Special Order

X3 Trolling Motor

C1

Foot-control, Bow Mount 12V X3**Specifications**

Thrust: 45 Lbs
 Voltage: 12V
 Column Length: 36", 45" & 50"
 Control: Pull/Pull
 Speed: 5
 2-Blade Weedless Prop

Part No. A29-X3-45FW 45**Foot-control, Bow Mount 12V X3****Specifications**

Thrust: 55 Lbs
 Voltage: 12V
 Column Length: 36", 45" & 50"
 Control: Pull/Pull
 Speed: 5
 2-Blade Weedless Prop

Part No. A29-X3-55FW**Foot-control, Bow Mount 24V X3****Specifications**

Thrust: 70 Lbs
 Voltage: 24V
 Column Length: 45", 50"
 Control: Pull/Pull
 Speed: 5
 2-Blade Weedless Prop

**Part No. A29-X3-70FW
A29-X3-70FW 50****VariMAX Transom Mount Trolling Motors**

C2

Transom Mount 12V 40 Lbs**Specifications**

Thrust: 40 Lbs
 Voltage: 12V
 Column Length: 30"
 Speed fwd/rev: 5/2

Part No. A29-ETV40-30**Transom Mount 12V 45 Lbs****Specifications**

Thrust: 45 Lbs
 Voltage: 12V
 Column Length: 36"

Part No. A29-ETV45 SW

	R3 Fresh Water Edition D1
	Transom Mount Aluminium Shaft
	Specifications Thrust: 30 Lbs Voltage: 12V Shaft Length: 30" Speed Control: 5/2 Part No. A29-R3-30HT A29-R3-30FW
	Transom Mount Aluminium Shaft
	Specifications Thrust: 40 Lbs Voltage: 12V Shaft Length: 36" Speed Control: 5/2 Part No. A29-R3-40HT
	Transom Mount Composite Shaft
	Specifications Thrust: 45 Lbs Voltage: 12V Shaft Length: 36" Speed Control: 5/2 Part No. A29-R3-45HT A29-R3-45HT D
	Transom Mount Composite Shaft
	Specifications Thrust: 55 Lbs Voltage: 12V Shaft Length: 36" Speed Control: 5/2 Part No. A29-R3-55HT A29-R3-55HT D

Tour Edition Digital Trolling Motor 50" 21 GATSPR D2



Specifications
 Thrust: 82 Lbs
 Voltage: 24V
 Column length: 50"
 Speed fwd/rev: variable

Part No. A29-E582

Tour Edition Digital Trolling Motor TR82L 45" 24V D3



Specifications
 Thrust: 82 Lbs
 Voltage: 24V
 Column length: 45"
 Speed: Variable

Part No. A29-E582T

Safari Weedless Prop E1



Part No.
48-8M0028330

Prop 2B - 3.0 E2



Part No.
48-MFF12405T

Prop Kit - 3.5 Taper E3



Part No.
M889287T

Prop Nut E3



Part No.
MAR09902T - Prop Nut ①
A29-GFEL-MG-R-DP - G Force motorguide prop nut - Red ②
A29-GFEL-MG-BK-DP - G Force motorguide prop nut - Black ②
A29-GFEL-MG-C-DP - G Force motorguide prop nut - Silver ②

Pin LG Prop E5



Part No.
MBR10202T

Machete Prop MotorGuide / Electric Motor E6



Part No.
48-18022A5 - 9.25 x 3.25"
48-MAF12046T - 10 x 3.25"
48-18024A5 - 10.5 x 6"
48-813730A3 - 11 x 5"

G Force Lift Assist E7



Part No.
A29-GFEQ-MG-BK-DP - Black
A29-GFEQ-MG-R-DP - Red

G Force Handle Wireless Motor / Cable Motor E8



Part No.
A29-GFH-CAIR-DP - G Force Handle wireless motor ①
A29-GFH-1R-DP - G Force Handle cable motor ②



LUBRICANTS AND PERFOMANCE OILS

TC - W3 Premium plus Blend

A1

Premium Plus Blend is the most advanced oil yet formulated for conventional 2-Stroke outboard engines.



Part No.

92-824856A5 - (5L) NB: Mandatory for DFI (Optimax Engines)

Optimax / DFI Oil with Synthetic Additive

A2

Increases lubricity, minimises carbon deposits and reduces smoke, protecting your engine at all times



Part No.

92-858037QB1 - 4L
92-858038QB1 - 10L

25W50 Synthetic Verado Oil 4 Litre

A3

* Decanted when available



Part No.

92-858084QE1
* 92-858119 - 5L

25W40 4-Cycle Synthetic Blend

A4

* Decanted when available

It provides advanced protection not offered by conventional automotive oils. For use in all MerCruiser, Sterndrive, and FourStroke engines. Provides superior friction, wear and engine corrosion protection.



Part No.

92-8M0086226
92-8M0086227
* 92-8M0086625-5L - 5 Litre

25W40 Inboard & Sterndrive 4-Cycle Engine Oil

A5

If used regularly, it will reduce engine wear and corrosion, protect bearings from chemical attack, keep pistons clean, prevent rings from sticking and inhibit rust and sludge deposits. Meets API Service SG/CD specifications.



Part No.

92-8M0086223 - 1 Litre
92-8M0086224 - 4 Litre

15W40 Diesel Engine Oil

A6

This multigrade SAE 15W - 40 diesel engine oil has been formulated to meet heavy duty requirements and to combat sludge and varnish formation.



Part No.

92-8M0096794

25W40 Synthetic Blend 4-Stroke Outboard Oil

A7

Recommended oil for use in Mercury's newest Verado engine. Recommended oil in all Mercury FourStroke engines. Designed, qualified and tested by Mercury engineering.



Part No.

92-8M0086226 - 1 Litre
92-8M0086227 - 4 Litre

10W30 FourStroke Outboard Oil

A8

Helps reduce wear, scuffing and scoring, prevent the formation of rust and sludge and inhibit the formation of unwanted, damaging foam.



Part No.

92-8M006220 - 1 Litre
92-8M006221 - 4 Litre

25W 50 Verado Synthetic Oil 1L

B1



Part No.
92-8M0096256 - 1 Litre

2 Stroke Synthetic Blended Oil

B2



Part No.
92-8M0078011 - 7.5 Litre

ATV/UTV 4-Stroke Oil

B3



Part No.
92-8M0058914

PWC 2-Stroke Oil

B4



Part No.
92-8M0058907 - 1 Litre
92-8M0058908 - 4 Litre

TC-W3 Premium Oil 2-Cycle

B5



Part No.
92-858021QB1 - 1 Litre
92-858022QB1 - 4 Litre
92-858023QB1 - 10 Litre

TC-W3 Premium Plus 2-Cycle

B6



Part No.
92-858026QB1 - 1 Litre
92-858027QB1 - 4 Litre

25W50 High Performance Synthetic Verado

B7



Part No.
92-8M0096727 - 4 Litre



BOAT ACCESSORIES

1" Twist Drain Plug

A1



Part No.
A37-009826
A37-40096 - Brass

Garboard Drain Plug

A2



Part No.
A37-009836 - Cast
A37-ATW7555-3 - Stainless Steel

Adaptor Foot Pump

A3



Part No.
62-8096852

Adaptor Air Fill

A4



Part No.
62-8096854

Valve Inflator

A5



Part No.
A37-VI

Chain Link Formed Stainless Steel

A6



Part No.
A37-12893L3 - 3/16" x 2"
A37-12895L3 - 1/4" x 2-1/4"

Motorwell Boot 4 1/4"

A7



Part No.
A37-11580
A37-C88001

Split Cable Boot with Mounting Ring

A8



Part No.
A37-CBS-1-DP - 3-1/2"
A37-CBS-4-DP - 4-1/2"

Stainless Steel Skeg Protector B1



Part No.
 A37-SKEG-M - Medium (60 B/F - 125)
 A37-SKEG-L - Large (V6 - MCM)
 A37-SKEG-T - Shark
 A37-SKEG-VL4 - Verado L4

Replacement Skegs - Universal B2

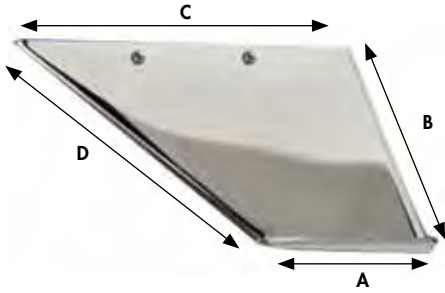

Part No.

	A	B	C	D
A37-RS-1-DP -	5-1/2"	6"	10-1/4"	9"
A37-RS-2-DP -	4-1/2"	5-3/4"	9-1/2"	10"
A37-RS-3-DP -	4"	4-1/4"	7-1/2"	7"
A37-RS-4-DP -	3-1/2"	6-1/2"	9-1/4"	10-1/2"

Adjustable Drink Holder B3



Part No.
 A37-11668 - White
 A37-11674 - Black

Ski Mirror B4



Part No.
 A37-13055 - Standard
 A37-C13065 - Wide View Ski Mirror 11 3/4" x 4"

Pull-Up Cleat B5



Part No.
 A37-003871 - Mini
 A37-39003 - 4 1/2"
 A37-39004 - 6"

S/S Cleat B6



Part No.
 A37-80040 - 8"
 A37-80036-06 - 31 6" Hollow

Solid Base Cleat B7
 150mm 6"



Part No.
 A37-30004 - 6"

Neat Cleat B8



Part No.
 A37-66502-1 - 3.5"
 A37-66515-1 - 4.5"
 A37-66517-1 - 6"
 A37-66519-1 - 8"

S/S Grab Rail

C1



Part No.

A37-GH200 - 200mm
A37-GH300 - 300mm
A37-GH400 - 400mm

30cm Oval S/S Grab Rail

C2



Part No.

A37-002246 - 30cm

Eye Bolts

C3

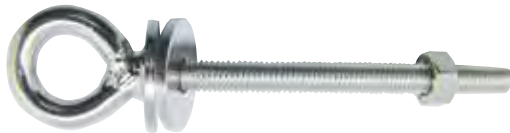

Part No.

A37-005288

Mounting Bolt Kit

C4

Bolt Kit for mounting outboard engines to jack plates or trim and tilt units.



Part No.

A37-BK-1-DP - 2 3/4"

Hatch Holder

C5



Part No.

A37-007928 - 11mm x 200mm
A37-007932 - 14.5mm x 260mm

U Bolts (AISI316 with nuts and washers)

C6



Part No.

A37-72301 - 4 x 64mm
A37-72303 - 5 x 80mm
A37-72306 - 6 x 60mm
A37-72307 - 8 x 80mm
A37-72308 - 8 x 100mm
A37-72310 - 10 x 130mm
A37-005713 - U Bolt
A37-005729 - U Bolt

D-Shackles

C7



Part No.

A37-20005 - 5mm
A37-55090 - 5mm
A37-000805 - A151316 - 5mm
A37-20006 - 6mm
A37-20008 - 8mm
A37-20010 - 10mm
A37-55091 - 6mm
A37-55093 - 8mm
A37-000810 - A151316 - 10mm
A37-000806 - 316 B - 12mm D-6mm

Snap Hooks

C8



Part No.

A37-0002805 - 316 - 5mm x 50mm
A37-0002806 - 316 - 6mm x 60mm
A37-0002807 - 316 - 7mm x 70mm
A37-0002808 - 316 - 8mm x 80mm
A37-0002810 - 316 - 10mm x 100mm

Bow Eye Single Shank AISI 316 D1



Part No.
A37-005735

Stainless Steel Bow Eye D2



Part No.
A-37-53554

3" Long Bow Eye Double Shank D3



Part No.
A37-005736

Transom Mount Ski Tow D4



Part No.
A37-53590-02

Transom Eye AISI 316 - 8mm x 75mm D5



Part No.
A37-005738

Transom Wedge D6



Part No.
A37-TW-2 DP - Transom Wedge - pair
A37-TW-3 DP - Reverse Transom Wedge - pair

Swivel Hasp D7



Part No.
A37-008375

C12089 Swivel Eye Hasp D8



Part No.
A46-C12809

Top Cap 22mm

E1



Part No.

A37-009946 - Straight
A37-009948 - 90°

Deck Hinge

E2



Part No.

A37-009955 - Flat
A37-009956 - Concave - 25mm

Jaw Slide 22mm

E3



Part No.

A37-009957

Deck Plates

E4



Part No.

A37-13560 - WH - 4" White Plastic Deck Plate
A37-C13021 - W8 - 4" White 8 hole Base
A37-C13021 - B8 - 4" Black 8 hole Base
A37-13566 - WH - 6" White Plastic Deck Plate
A37-C13025 - W8 - 6" White 8 hole Base
A37-C13025 - B8 - 6" Black 8 hole Base

Inspection Hatch

E5



Part No.

A37-N0709074 - 4" White Inspection Hatch
A37-N0709080 - 4" Black Inspection Hatch
A37-N0715080 - 6" Black Inspection Hatch
A37-073810 - Inspection Port White Hole 111mm

Flush Mount Hasp / Staple

E6



Part No.

A46-66423-3

Access Hatch

E7



Part No.

A37-L5427375 - 375 x 270mm
A37-L5437375 - 375 x 370mm
A37-L5435606 - 353 x 606mm

Thru Hull Scupper 1 1/2"

E8



Part No.

A37-RFTH-2BCP - Chrome W/Black flapper

Outboard Motor Bracket

F1

**Part No.**

A37-72532 - Up to 10Hp
A37-72534 - Up to 20Hp

QS Centre Hole Fender

F2

**Part No.**

67-885909 - White 43cm
67-885910 - Blue 43cm
67-885912 - White 55cm
67-885913 - Blue 55cm

Inflatable White Cyl Fender

F3

**Part No.**

A37-P1515043 - 150 x 430mm
A37-P1520055 - 200 x 550mm

Torque Tab

F4

**Part No.**

A37-TAB-1-DP

Telescopic Boat Hook

F5

**Part No.**

A37-R0030060 - Mini Cadet
A37-R0430118 - Cadet New
A37-11510-5 - 3 1/2-5
A37-1180-5 - 3 1/2-8

Deck Brush Kit

F6

**Part No.**

A37-C11808

Contour Fender

F7

**Part No.**

A37-C11924L - 24" Contour Fender - Blue
A37-C11924 - 24" Contour Fender - White
A37-C11926L - 26" Flat Fender - Blue
A37-C11926 - 26" Flat Fender - White
A37-C11930L - 30" Contour Fender - Blue
A37-C11930 - 30" Contour Fender - White

Capsize Container Holders

F8

**Part No.**

A37-CCH

Storage Rod Holder

G1



Part No.
A37-12750B - Three
A37-12752B - Five

Rod Storage Rack

G2



Part No.
A37-54065 - Horizontal

S/S Rod Holder

G3



Part No.
A37-54068 - S/S
A37-54075

Rod Holder Vertical Mount with Bracket

G4



Part No.
A37-12706 - 2 Rod Holder
A37-12707 - 3 Rod Holder
A37-12717 - 4 Rod Holder

Side Mount Rod Holder

G5



Part No.
A37-C12715

Side Mount Swivel Rod Holder

G6



Part No.
A37-12740

Rod Holder S/S with Cap

G7



Part No.
A37-80276

S/S Rod Holder White Cap

G8



Part No.
A37-12716

Flush Mount Rod Holder

H1



Part No.
A37-12700 - White
A37-12701 - Black

Sling Shot Rod Holders

H2



Part No.
A37-SRH

Rod Holder Mount

H3



Part No.
A37-5010-4 - Combo Mount
A37-5013-4 - Flush Mount - Black

Flush Mount Rod Holder Chrome

H4



Part No.
A37-12702

Deck Mount Rod Holder

H5



Part No.
A37-C12764

Spring Rod Holder

H6



Part No.
A37-SR

Tube Rod Holder Adjustable

H7



Part No.
A37-TRH

Glove Box and Adjustable Drink Holder

H8



Part No.
A37-C12201

S/S Cup Holder 304

11



Side view

Part No.
A37-54097

Can Holder

12



Part No.
A37-54099-02BU - LED 3/8" Blue
A37-54099-02RD - LED 3/8" Red

Stainless Steel Cup Holder 3-3/4"

13



Part No.
A37-C11675

Stainless Steel Cup Holder Adjustable

14



Part No.
A37-54098

Glass Holder W/Steel Cover

15



Part No.
A37-D1711715

Bass Boat High Chair

16



Part No.
A37-BHC

Telescopic Ladder Short Bracket

17



Part No.
A37-71060-03 - 3 Step - Top mount
A37-71063-03 - 3 Step S/S - Slide under platform

3 Step Telescopic Ladder

18



Part No.
A37-000713 - Platform Ladder
A37-000720 - Drop Ladder

4 Step Ladder AISI 316 with Handle

J1



Part No.
A37-000733

Step - White

J2



Part No.
A37-L5374160

Hose Clamp

J3



Part No.
A37-HC001 - 5.5mm - 15.8mm
A37-HC002 - 9.5mm - 22.2mm
A37-HC003 - 14.2mm - 31.8mm
A37-HC004 - 26.9mm - 38.1mm
A37-HC005 - 19.1mm - 44.5mm
A37-HC006 - 39.7mm - 63.5mm

Plastic Drain Plug

J4



Part No.
A37-40097-BK

Kayak Paddle

J5



Part No.
A37-C50427

Standard Paddle 152mm

J6



Part No.
A37-50112

Telescopic Paddle

J7



Part No.
A37-C50119P - Black 30 - 42"
A37-C50300 - Orange 22 - 42"

Lure Rack

J8



Part No.
A37-11848-4

White Box Hatch

K1



Part No.

A37-L5416375 - 270mm x 375mm
A37-L5416607 - 243mm x 607mm

White Access Rectangular Hatch

K2



NO IMAGE
AVAILABLE

Part No.

A37-L5446510 - 460mm x 510mm

Stainless Steel Turn Buckle - F

K3



Part No.

A37-80080-01 - 110mm - 170mm
A37-80080-02 - 150mm - 220mm
A37-80080-03 - 165mm - 240mm
A37-80080-04 - 190mm - 280mm
A37-80080-05 - 245mm - 360mm
A37-80081-01 - 2.2mm
A37-80081-02 - 3.5mm
A37-80081-03 - 4.3mm
A37-80081-04/1 - 6.4mm

Stainless Steel Turn Buckle

K4



Part No.

A37-53540 - 70mm - 120mm
A37-53542 - 120mm - 200mm
A37-53544 - 200mm - 310mm

Stainless Sweiger Steel Turn Buckle - Type 316SS

K5



Part No.

A37-80081-01 - 2.2mm
A37-80081-02 - 3.5mm
A37-80081-03 - 4.3mm
A37-80081-04/1 - 6.4mm

Turn Buckle Eye

K6



Part No.

A37-83541-04 - 150mm - 240mm
A37-83541-05 - 200mm - 310mm
A37-83541-06 - 250mm - 390mm

Turn Buckle Eye

K7



Part No.

A37-83544-02 - 6mm
A37-83544-03 - 8mm
A37-83544-04 - 10mm
A37-83541-05 - 68mm

Snap Hook

K8



Part No.

A37-55070 - 5 x 50 x 25mm
A37-55071 - 6 x 60 x 30mm
A37-55071/1 - 35mm
A37-55072 - 8 x 80 x 40mm

Dry Bag

L1



Part No.
 A37-11887-2 - Large clear
 A37-11894-2 - 40L
 A37-11897-2 - 20L

Mesh Storage Bag

L2



Part No.
 A37-11888D5

Antenna Base

L3



Part No.
 A37-12680-3

Clamp-on Ski Mirror

L4



Part No.
 A37-13066-7

Elastic Net Hatch

L5



Part No.
 A37-Z0018370 - 180 x 365 - Black
 A37-Z0074115 - 270 x 115 x 32 - White
 A37-Z0074370 - 180 x 365 - White

Elastic Net

L6

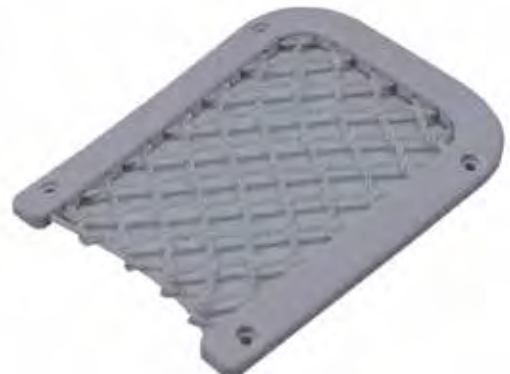

Part No.
 A37-N1774126

Lock and Stow

L7



Part No.
 A37-10107 - 225 - 250Hp Efi & Optimax
 A37-10108 - 75 - 200Hp Efi & 135 - 175Hp Optimax

Transom Strap Retractable

L8



Part No.
 A37-15230-1 - 2ft x 2 inch pair - non ratchet
 A37-15230-7 - 2ft x 2 inch - non ratchet
 A37-15160-8 - 6ft x 1 inch ratchet
 A37-15260-8 - 5.5ft x 2inch ratchet

Door Hinge Stainless Steel - 2"

M1



Part No.
A37-66391-3 - 2" x 1.5" Pair

Door Hinge Stainless Steel - 4"

M2



Part No.
A37-66028-3 - 4" x 1.1/2" Pair

Flush Hinge Round End Stainless Steel

M3



Part No.
A37-66237-1

Flush Hinge Square End Stainless Steel

M4



Part No.
A37-66239-1

Hinges

M5



Part No.
A37-52570 - 74mm x 39mm

Hinges

M6



Part No.
A37-52595 - 51mm x 38.1mm

Hinges

M7



Part No.
A37-52592 - 85mm x 26mm

Hinge S/S 37 x 84mm

M8



Part No.
A37-M3575037 - 37mm x 84mm

Reverse Hinge - AISI-304 N1



Part No.
A37-006086 - 39mm x 76mm

Hinges N2



Part No.
A46-008621 - With Thread (1-9/16" x 5") Aisi 316

Hinges N3



NO IMAGE AVAILABLE

Part No.
A46-008624 - With Thread (1-9/16" x 2-9/16") Aisi 316

Butt Hinge ZAMAK N4



Part No.
A46-12000-3

Door Hinge N5



Part No.
A46-660293-3

Round Hinge N6



Part No.
A46-66240-1 - Counter Sunk Hinge S/S

Continuous Hinge N7



NO IMAGE AVAILABLE

Part No.
A46-12081HD - S/S 48"

Hinges Take Apart N8



Part No.
A46-85024
A46-1329-3 - 4' x 2"

Heavy Duty Seat Swivel

O1



Part No.
A37-12561

Fold-down Seat

O2



Part No.
A37-C12504 - White

Boat Seat Fisherman

O3



Part No.
A37-01450000

Captains Chair

O4



Part No.
A37-01411000

Attwood Kit Plast Universal

O5



Part No.
A37-ATW-98900-9 - Attwood plastic kit
A37-ATW-ATT200-1 - Attwood foam kit

Attwood Aergo Single Kit

O6



Part No.
A37-ATW98963-1

Pedestal Fixed Height 11"

O7



Part No.
A37-238911L1 - Thin base

Bell Pedestal 2-7/8

O8



Part No.
A37-860801 - Thick pole

Pedestal Fixed Height 300mm P1



Part No.
A37-C12600D

Pedestal Adjust P2



Part No.
A37-C12590D - 340 - 510mm
A37-C12592D - 500 - 750mm

Seat Slide 360 Rotation P3



Part No.
A37-C12594

Seat W/Slider 3 Deg Tilt P4



Part No.
A37-828461 - Thin base
A37-828660 - Thick base

Door Lock Stainless Steel 316 60mm P5



Part No.
A37-N3060000

Trailer Clips P6



Part No.
A37-TC-1-DP

Steer-Stop Steering Lock W/Trailing P7



Part No.
A37-SS-1-DP

Utility Grommet P8



Part No.
A37-UG-3

Strain Relief Hose Kit

Q1



Part No.
A37-BSR-1K - Small
A37-BSR-1-FH - Large

Transom Support Plate

Q3



Part No.
A37-TSP-1 - 15" x 2" x 13"

Custom-Fit Mercury Motor Covers

Q2

The official Mercury logo is displayed in brilliant white against a sleek black background. These covers protect and fit far better than typical universal hoods...plus they show your Mercury pride on the road.

Note: Construction and shape of cover may vary due to different engine styles.



Engine Description	Engine Size	Part No.
4-Stroke EFI	40Hp, 50Hp, 60Hp	A37-105651
Optimax 1.5L	75Hp, 90Hp, 115Hp, 125Hp	A37-105635
Optimax 3.0L 2-Stroke 3.0L EFI	200Hp, 225Hp, 250Hp 200Hp, 225Hp, 250Hp	A37-105638
Verado L4	135Hp, 150Hp, 175Hp, 200Hp	A37-105648
Verado L6	200Hp, 225Hp, 250Hp, 275Hp, 300Hp	A37-105639
2-Stroke 2.5L V-6 EFI 2.5L V-6 Carb 4-Stroke 2-Stroke	150Hp, 200Hp 150Hp, 200Hp 75Hp, 90Hp, 115Hp 75Hp, 90Hp	A37-105637



BOSS MARINE AUDIO



Boss Marine Mechless

R1



Part No.
A37-MCK1306W.64 - 6.5" Speakers 180 Watt

Boss Marine Mechless

R2



Part No.
A37-MOV1307W.6 - 6.5" Speakers 180 Watt

Boss Marine Radio Set

R3



Part No.
A37-MCK1440W.64 - 6.5" Speakers 180 Watt

Boss Marine Radio Set

R4



Part No.
A37-MCKGB350W.6 - 6.5" Speakers 180 Watt

Boss Marine MP - System

R5



Part No.
A37-MCK508WB.6 - 6.5" Speakers 180 Watt

Boss Marine CD with Speakers

R6



Part No.
A37-MCK648W.6 - 6.5" Speakers 180 Watt

Boss Marine Audio Radio

R7



Part No.
A37-MGR350B - Bluetooth, Aux, USB

Boss Marine Silver / White Finish

R8



Part No.
A37-MR508UABS - Silver - Bluetooth, Aux, USB
A37-MR508UABW - White - Bluetooth, Aux, USB

Boss Marine Radio S1



Part No.
A37-MR762BRGB - Bluetooth, Aux, USB

Boss Marine Audio Radio S2



Part No.
A37-MR1306UA - Silver - Aux, USB, SD

Boss Marine Audio Radio S3



Part No.
A37-MR1308UAB - White - Bluetooth, Aux, USB, SD no CD
A37-MR1308ABK - Black - Bluetooth, Aux, USB, SD no CD

Boss Marine 4" 2-way 400W Speakers S4



Part No.
A37-MRWT40

Boss Marine Speakers S5



Part No.
A37-MR652C - 6.5" 350W
A37-MR752C - 7.5" 400W

Boss Marine Speaker S6



Part No.
A37-MR6W - White 180 Watt
A37-MR6B - Black 180 Watt

Boss Marine WT Speaker S7



Part No.
A37-MRWT69RGB - 800 Watt 6 x 9" Individual

Boss Marine Speakers 150W S8



Part No.
A37-MR60W - White 200 Watt
A37-MR60B - Black 200 Watt

Boss Marine Speakers 200W

T1



Part No.
 A37-MRGB65S - Silver 200 Watt
 A37-MRGB65B - Black 200 Watt
 A37-MRGB65 - White 200 Watt

Boss Marine Speakers - 5.25"

T2



Part No.
 A37-MR50W - White 150 Watt
 A37-MR50B - Black 150 Watt

Boss Marine Speakers 6 x 9"

T3



Part No.
 A37-MR690 - 350 Watt

Boss Speakers 6 x 9"

T4



Part No.
 A37-MR692W - 350 Watt
 A37-MR692B - 350 Watt

Boss Marine Speakers 6.5 x 2"

T5



Part No.
 A37-MR62W - 200 Watt

Boss Marine Speakers 6.5 x 2"

T6



Part No.
 A37-MR62B - 200 Watt

Boss Marine Speakers 5.25 x 2"

T7



Part No.
 A37-MR52B - 150 Watt

Boss Marine Speakers 5.25 x 2"

T8



Part No.
 A37-MR52W - 150 Watt

Boss Marine Speakers Subwoofer 10" - 600W

U1



Part No.
A37-MR101

Boss Marine Speaker Subwoofer 12" - 800W

U2



Part No.
A37-MR121

Boss Marine Speakers Subwoofer 10" - 1000W

U3



Part No.
A37-MR105

Boss Marine W/Tower 750W 2-2Way Amplifier

U4



Part No.
A37-BM650AMPBT

Boss Marine Amplifier - 400W

U5



Part No.
A37-MR1004

Boss Marine 800W 2-Channel Bridge Amplifier

U6



Part No.
A37-MR800

Boss Marine Amplifier - 1000W - 4 Channel

U7



Part No.
A37-MR1000

Boss Marine Amplifier 1200W 4 Channel

U8



Part No.
A37-MR1200PA

Boss Marine Multi-media Receiver

V1



Part No.
 A37-MGR450B - Head Unit
 A37-MGR420R - Wired Remote Control
 A37-MGR25C - Remote Control Cable

Bluetooth, USB AUX

Boss Marine Amp Kit

V2



Part No.
 A37-ASK904B.64 - 180 Watt Speakers

Boss Marine USB Cable

V3



Part No.
 A37-MUSB35

Boss Marine Dipole Antenna

V4



Part No.
 A37-MRANT10

Boss Marine Radio Covers

V5



Part No.
 A37-MRC5 - White
 A37-MRC5B - Black

Boss Marine Flush Mount Radio Cover

V6



Part No.
 A37-L4660727



Keep Slipway
Clear

TRAILER ACCESSORIES

Side Roller

A1



Part No.
A39-O0809001 - 76mm x 76mm

Bow Roller

A2



Part No.
A39-C11219 - 5" x 7" L
A39-11857-1 - 3.5" x 4"

Central Roller

A3



Part No.
A39-O0809003 - 130 x 77 14mm holw

3" Poly Bow Stop - Black

A4



Part No.
A39-C11303B - 3"

10" Rubber Tie Down

A5



Part No.
A39-10926

Trailer Felt

A6



Part No.
A39-Felt-50 - 10m x 50mm x 10mm
A39-Felt-75 - 10m x 75mm x 10mm
A39-Felt-100 - 10m x 100mm x 10mm
A39-Felt-150 - 10m x 150mm x 10mm

Tow Coupler

A7



Part No.
A39-CUK0750 - 750kg no lock
A39-CUK2700 - With Keys/Lock 750kg

Winches

A8



Part No.
A39 - A63500-ZP - 600Lb ZNK PLT
A39 - A63501-ZP - 850Lb ZNK PLT
A39 - Winch - 600 - WT-73-06 Hand Winch 600 Lbs
A39 - Winch - 850 - WT-73-08 Hand Winch 850 Lbs
A39 - Winch - 1200 - WT-73-12 Hand Winch 1200 Lbs
A39 - Winch - 1600 - WT-73-16 Hand Winch 1600 Lbs
A39 - Winch - 2000A - WT-77-20 Hand Winch 2000 Lbs
A39 - Winch - 2500 - WT-73-25 Hand Winch 2500 Lbs

Winch Webbing B1



Part No.
A39-12

Winch Cable B2



Part No.
A39-C11003

Dual Winch with Brake B3



Part No.
A39-BQW1760 - Includes webbing and hook 800kg
A39-BQW2500 - Includes webbing and hook 1134kg

Trailer Spare Wheel Hold with Bracket B4



Part No.
A39-C11091

Top wind Jack B5

WT - 15 Max Load 125kg
WT - 25 Max Load 360kg



Part No.
A39-11115 - 33mm
A39-11125 - 48mm

Swing Up Jack B6



Part No.
A39-11128 - 50mm

Swivel Spring Loaded Jockey Wheel B7



Part No.
A37-85002-02
A37-85002-03



LIGHTS, SWITCHES AND BATTERIES

White LED All Round Light

A1

**Part No.**

A40-C25015SC - 24" Stainless Steel
 A40-C25015 - 24" Black Plastic Plug In Base
 A40-C25017 - 42" Black Plastic

All Round Light Water Resistant

A2

**Part No.**

A40-00126 - L 2.5" Standard Light

Removable Pole Light

A3

Stainless Steel Base 24" High

**Part No.**

A40-050302 - 24" S/S Base

Stern Lamp

A4

**Part No.**

A40 - 14024 - 24" Stern Lamp Telescopic
 A40 - 14025 - 24" Stern Lamp Plug-in

Perko Bi-colour Light Chrome

A5

**Part No.**

A40 - 227000CHR - Standard Light

Perko Pole Storage Clip

A6

**Part No.**

A40 - 477000BLK

Perko Port / Starboard Pair

A7

**Part No.**

A40-228000CHR - Pair Chrome Standard Light

Small Round Combo Bow Light

A8

**Part No.**

A40-00153 - Stainless Steel

Standard Combo Bow Light

B1



Part No.
 A40-050241 - Chrome
 A40-0015 - Standard Kight Combo

Bi-Colour Plug in Bow Light Black

B2



Part No.
 A40-1612002BLK - 12" Standard

Bi-colour Combo Bow Light

B3



Part No.
 A40-C91017 - LED S/S

Courtesy Light

B4



Part No.
 A40 - 00155 - Plastic Courtesy Light

Courtesy Light

B5



Part No.
 A40 - 00178-WH - Courtesy Light - White

Led Cabin Light White

B6



Part No.
 A40 - C91014W - LED

LED Navigation Side Lights Port / Starboard Pair

B7



Part No.
 A40 - C91006PB-1 - Black - Pair
 A40 - C911065-1 - Chrome Pair

Horizontal Mount Navigation Side Light

B8



Part No.
 A40-L5880530 - Port Side - Red
 A40-L5880550 - Starboard - Green

Stainless Steel side Flush Light

C1



Part No.
A40-00195

Chart Light

C2



Part No.
A40-01330 - Cigarette Light/Chart Light
A40-01335 - Cigarette Plug

Remote Controlled Spot Light

C3

- Water resistant
- Sealed beam 12V 55W
- Rotation 440 degrees
- Tilt 75 degrees
- Supplied with fixed and suction base



Part No.
A40-01652-BK - Black Housing
A40-01652-WH - White Housing

Wireless remote Controlled Spot Light

C4

- Water resistant
- Sealed beam 12V 55W
- Rotation 440 degrees
- Tilt 75 degrees
- Supplied with fixed and suction base



Part No.
A40-01651-BK - Black Housing
A40-01651-WH - White Housing
A40-01654-BK - Black Magnetic Base
A40-01651-01 - Remote Control

Working Light Bulk Head

C5



Part No.
A40-01656-BKHD

Battery Switch

C6



Part No.
A40-14230 - Battery Switch

Battery Switch

C7



Part No.
A40-10097 - C10097 Battery Isolator Switch
A40-10097-KEY - Battery Switch Spare Key
A40-10097-PB - Battery Switch With PVC Key

Battery Switch Single

C8



Part No.
A40-10092

Kill Switch D1



Part No.
A40-10286 - Universal Kill Switch W/Cord

Kill Switch Keys and Lanyard D2



Part No.
A40-10284

Kill Switch with Lanyard D3



Part No.
A40-10287

Universal Cut Out Switch D4



Part No.
A40-L0600130

2P On / Offswitch - Push / Pull 12V Long Shank D5



Part No.
A40-10212-2PB

Push / Pull Switch - Short Shank D6



Part No.
A40-10217

Waterproof Switch D7



Part No.
A40-10123-02 - 3P (On) - Off (hooter)
A40-10124-01 - 4P On - Off
A40-10125-01 - 5P (On) - Off - On
A40-10126-01 - 6P On - Off - On

Splash Proof Switch D8



Part No.
A40-10044-W - 4 Gang Switch White
A40-10064-W - 6 Gang Switch Panel

Bilge Pump Switch

Fits 3/4" Diameter Tubing

E1



Part No.
A40-10296

Switch Panel

E2



Part No.
A40-14234 - 3 Gang
A40-14236 - 6 Gang

Waterproof Switch Panel 12V

E3



Part No.
A40-10013-BK - 3 Gang Switch Panel - Black
A40-10013-WH - 3 Gang Switch Panel - White
A40-10016-BK - 6 Gang Switch Panel - Black
A40-10016-WH - 6 Gang Switch Panel - White

Switch Panel 3 Gang with 5 Amp Fuse

E4



Part No.
A40-10035-BK ①
A40-10037 ②

Water Resistant Panel 12V

E5



Part No.
A40-10054-BK - 4 Position
A40-10056-BK - 6 Position

Waterproof Gang Switch Panel

E6



Part No.
A40-10047-BK - 4 Gang
A40-10067 - 6 Gang

Labels for Waterproofing Switch

E7



Part No.
A40-P10063-03

Power Socket Set 12V

E8



Part No.
A40-3024

Cigarette Socket Panel

F1



Part No.
A40-70063-BK

US Battery - Deep Cycle

F2

Industrial Ref: 12V 31XHS M.31
A/H at 20hr rate: 130
Warranty: 1 year



Part No.
A40-US-31DCXC

Deep Cycle Marine

F3



Part No.
A40-BV-LFD - 60
A40-BV-LFD - 75

FULMEN

F4

Industrial Ref: 652
A/H 74
Warranty: 2 years



Part No.
A40-BF-652FB-74

VARTA

F5

Industrial Ref: 652HC
A/H at 20hr rate: 74 Teri
Layout: RHP Tapered
Warranty: 2 years



Part No.
A40-BV-2074 - Varta 652 HC (E11)

Deltec Neutral

F6

Industrial Ref: 652
A/H at 20hr rate: 70
Terminal Layout: RHP Tapered
Warranty: 2 years

Industrial Ref: 674 Taper S/BY
A/H at 20hr rate: 102
Terminal Layout: CL Tapered
Warranty: 2 years

Industrial Ref: 674 D/Cycle Taper
A/H at 20hr rate: 105
Terminal Layout: CL Tapered
Warranty: 2 years



Part No.
A40-BD-2070N - Deltec Neutral 652
A40-1251N - Deltec Neutral 674 Taper S/by
A40-BD-54-105N - Deltec Neutral 674D/C (A24)

Deltec Neutral - Semi Sealed AMF (YB Series)

F7

Industrial Ref: YB16CL-B
A/H at 20hr rate: 19
Terminal Layout: RHP
Warranty: 1 year

Industrial Ref: YB30CL-B
A/H at 20hr rate: 30
Terminal Layout: RHP
Warranty: 1 year



Part No.
A40-FB-YB14CL-B - YB14CL-B
A40-FB-YB16CL-B - YB16CL-B
A40-FB-YB30CL-B - YB30CL-B

Optima

F8

Industrial Ref: BT DC 5.5
A/H at 20hr rate: 75
Terminal Layout: LHP STUD / Terminal
Warranty: 1 year



Part No.
A40-BVO - B55SL - BT SLI 4.2
A40-BVO - B75L - BT DC 5.5

Battery Terminals

G1



Part No.
A40-828 - Battery Terminals

Battery Charger with Float Auto

G2



Part No.
A40-BFA-012-230

Smart Battery Charger

G3



Part No.
A40-BAC-104WR

Waterproof USB Port

G4



Part No.
A40-10120 - Switch Dual

Waterproof Switch

G5



Part No.
A40-10140-U - 3 Switch Panel USB
A40-10140-V - 3 Switch Panel DV
A40-10160-BKU - 5 Switch Panel USB
A40-10160-BKV - 5 Switch Panel DV

LED Switch Panel

G6



Part No.
A40-C91350 - 4 Gang
A40-C91352 - 6 Gang

Mini Charger USB Type

G7



Part No.
A40-01343

2 Port USB Type

G8



Part No.
A40-01433 - W/DVLT
A40-01434 - W/Power Socket

M300 CTEK Marine Charger H1



Part No.
A40-56-298

MXS 5.0 EU CTEK Charger H2



Part No.
A40-56-305

MXS 3.8 EU CTEK Charger H3



Part No.
A40-56-309

MXS 7.0 EU CTEK Charger H4



Part No.
A40-56-731

MXS 14 EU CTEK Charger H5



Part No.
A40-56-734

D250S Dual CTEK Charger H6



Part No.
A40-56-677

XS0.8/12V EU CTEK Charger H7



Part No.
A40-56-707

Tolling Motor Connector H8



Part No.
A40-7622-7

Trim Control - Fingerflex

11



Part No.
A40-FFTB-1-DP

Underwater 12V Light Black / White

12



Part No.
A40-L4306536 - Blue
A40-L4406536 - White



NAVIGATION

Ritchie Explorer Compass B-51, 2 3/4" Dial A1
Bracket Mount



Part No.
A41-B-51 - Black
A41-B-51G - Grey
A41-B-51W - White

Ritchie Explorer Compass F-50, 2 3/4" Dial A2



Part No.
A41-F-50 - Black
A41-F-50W - White

Ritchie Explorer Compass D-55, 2 3/4" Dial A3



Part No.
A41-D-55 - Black

Ritchie Voyager Compass B-81, 3" Dial A4
Bracket mount



Part No.
A41-B-81

Ritchie Voyager Compass F-83, 3" Dial A5
Flush Mount



Part No.
A41-F-83 - Black
A41-F-83W - White

Ritchie Angler Compass RA-91 & RA-93, 2 3/4" Dial A6



Part No.
A41-RA-91 - Grey
A41-RA-93 - Grey

Ritchie Trek Compass TR-35, 2 1/4" Dial A7
Flush Mount



Part No.
A41-TR-35 - Black
A41-TR-35G - Grey
A41-TR-35W - White

Ritchie Sport Compass X-10, 2" Dial A8
Bracket Mount



Part No.
A41-X-10-M
A41-X-10B-M - Black
A41-X-10W-M - White

Plastic Hand Held Compass B1



Part No.
A41-70021
A41-L2535135

Compass B2



Part No.
A41-70030-BK - Black
A41-70030-WH - White

Compass B3



Part No.
A41-70032-BK - Black
A41-70032-WH - White

Black Compass with Bracket B4



Part No.
A41-70031-BK - Black
A41-70031-WH - White

Adhesive Navigation Codes B5



Part No.
A41-D1513017

NAVIGATION OPTIMIZATION

When it comes to attaining optimal navigation performance and safety, there are two things to take into consideration the assimilation of magnetic and electronic data, and the compass selection process. Each plays a critical role in getting you where you need to go safely and efficiently.

Assimilating Magnetic and Electronic Navigation Data

Even with the onset of electronic navigation, the compass is still the cornerstone of any navigation system. To achieve optimal safety and efficiency, it is necessary to coordinate the use of both electronic and magnetic navigation.

Using GPS Data and Compass Data Together

A GPS is a great tool when used in combination with your compass. It informs you of your boat's position, using data from multiple satellites. The GPS computer will store that data and use it to calculate both the speed and direction in which your boat has been traveling. But this information says nothing of the real-time heading of your boat. Wind, current, boat speed, and boat characteristics can all create a discrepancy between what's really happening and what a GPS indicates. And that's where a Ritchie compass can help you out.

Benefits of Real-time Navigation Data

A captain needs real-time heading information to navigate properly. And when it's correctly installed and compensated, a compass will provide that information, no matter the time or speed, under any circumstances - including a power outage. You can depend on a compass to maintain a consistent course while you're underway, which greatly affects fuel consumption, time of travel and ease of steering. If you rely exclusively on a GPS, you'll not only be compromising performance, but safety as well.

Compass Selection and Installation

On many boats, dashboard and cockpit space are taken up largely by other marine instrumentation and electronics. As a result, captains of both sail and powerboats are relying on compasses that are either too small or incorrectly positioned or mounted. This may seem like a minor detail, but it is actually vital to boating safety, performance and efficient navigation. When you select a compass, you should always consider size, readability of the card, and the design of your boat.

MAGNETIC NAVIGATION OVERVIEW

While you may have a grasp on the importance of a compass, if you're like most people, you probably aren't too sure how it works or how you might need to adjust it. But before you have one installed, it's necessary to have a basic knowledge of the inner workings of your compass.

How a Compass Works

Think of the Earth as having a powerful magnetic bar near its center. The compass needle consists of small, lightweight magnets balanced on a nearly frictionless pivot point. The concept behind a compass is that when that magnet is suspended in the Earth's magnetic field, it will align itself parallel to the force of that field, and thus establish a direction.

The Difference Between True North and Magnetic North

Since the Earth's magnetic properties are not uniformly distributed, its magnetic poles are not in the same locations as the geographic poles that you are familiar with. There are two magnetic poles, one in the northern hemisphere (over 600 miles from the North geographic pole) and one in the southern hemisphere (nearly 1500 miles from the South geographic pole). Your compass will not point to the geographic, or true, North - which can be determined by using the compass rose on your paper chart. Nor will it provide the correct direction to the North magnetic pole. But what it will do is give you a reliable, consistent direction, which will remain constant over a period of several years.

Compass Adjustments

Before using your compass, it is important to understand the factors that affect its performance. That way, you can make appropriate adjustments before getting underway.

Information courtesy of Ritchie's Complete Guide to Compass Navigation.

Visit www.ritchienavigation.com to download the complete guide



SAFETY EQUIPMENT

Flags



A1

Part No.

A42-1551 - Distress Flag V 45 x 30
 A42-1553 - Flag C 640 x 355
 A42-1554 - Flag N 640 x 355
 A42-1555 - Flag A 640 x 355

Stainless Steel Signalling Mirror

A2



Part No.

A42-1560

Sound Signalling Devices

A3



Part No.

A42-15007 - Plastic Fog Horn
 A42-10500009 - Plastic Whistle (White)
 A42-10289 - Plastic Whistle (Red)

Radar Reflector

A4

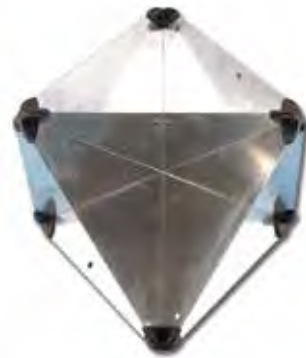

Part No.

A42-13400041

Capsize Canister

A5



Part No.

A42-1509FS - Capsize Canister 15 Litre
 A42-1509F - Capsize Canister 20 Litre (Full)
 A42-1509 - Capsize Canister 20 Litre
 A42-1510 - Spare Lid

First Aid Kits

A6



Part No.

A42-6000 - First Aid Kit 4-Man Ski-boat
 A42-6003 - First Aid Kit 6-Man
 A42-6005 - First Aid Kit Zip Up Bag 4-Man

Rescue Blanket

A7



Part No.

A42-1552

Orange Sheet

A8



Part No.

A42-1550 - 100 x 300

Fire Extinguishers

B1



Part No.
 A42-F100 - 1Kg Extinguisher with Bracket
 A42-F150 - 1.5Kg Extinguisher with Bracket

Waterproof Rubber Torch

B2



Part No.
 A42-L2000021

Tool Kit

B3



Part No.
 91-16229
 91-95399

Ring Lifebuoy

B4



Part No.
 A42-N1455030 - Lifebuoy Ring Red and White 57 x 34cm
 A42-N1435060 - Lifebuoy 2,5kg - Orange

Solid Head Buoy / Lifebuoy

B5



Part No.
 67-8856801 - Solid Head Buoy White 45 x 62cm

Mooring Buoy
 250ml - Orange

B6



Part No.
 A42-P1125001

Mooring Buoy

B7

12"



Part No.
 A42-C11762

SAFETY CATEGORY CHECK LIST

DESCRIPTION	QUANTITY				
	B	C	D	E	R
Capsize Bottle with lanyard the width of the boat attached to contain the following	1	1	1	1	
UN-expired approved Red / Orange Hand Held Distress Flares	4	2	2	1	
UN-expired approved Red Rocket Parachute Flares or sets	4	2	2	1	
UN-expired approved Orange Smoke Floating Marker	1	1	1		
Space Blankets	2	2	2	2	
Waterproof Torch, Batteries & Spare Globe (for night operations)	1	1	1	1	
Handheld 12v Spotlight with own battery (for night operations)	1	1	1		
One Lt of Drinking Water per person					
Approved First Aid Kit with cross on green background on container	1	1	1	1	1
Approved Life Jacket or Life Vest per person on board LEVEL 150					1
Suitable Magnetic Compass, which bearings can be taken	1	1	1		
Suitable Magnetic Compass, which bearings can be taken (Hand Held)	1	1	1	1	
Fire Extinguisher, one per engine. Dry Powder 1.5kg dated & serviced	2	2	2	1	1
Capsize Rope suitable for the type of craft	1	1	1	1	1
Sea Anchor rigged for surf launching with trip rope ready to use	1	1	1	1	
Anchor, proper patented, suitable for operating area	1	1	1	1	1
100m - (50m for Category E) Suitable Anchor Rope	1	1	1	1	1
Suitable Chain not less than 3m in length for boats under 6m (5m for more than 6m)	1	1	1	1	1
Bow Eye and Stern Eye	1	1	1		
Anchor Ballard	1	1	1		
Suitable Scuppers	2	2	2		
Petrol Tanks must be UN-approved in accordance with SAMSA regulations (Jerry Can)					
Spares (adequate for carrying out emergency repairs machinery incl. fuses & spark plugs)				1	1
Tools (as above i.e. for the purpose)				1	1
Inflatable to have Air-Bellows and Repair Kit				1	1
All equipment to be marked with Boat Registration Number					
Boat trailer must be marked, with owner's name, boat registration & contact numbers					
Emergency Steering	1	1	1	1	1
Identify Sheet (red, orange or yellow)	1	1	1	1	
Navigation Lights (for night operations)					
Bucket (bailing device)				1	1
Code Flag 'V' or 'N' & 'C'				1	
Mirror, Knife and Sound Signaling Device (operating to the west of Port Alfred)				1	
Radar Reflector					
Depth-sounding device or Hand Lead Line (Dive boats only)					
Grab Line to outside of Gunwales (Dive boats only)					
Suitable Paddles or Oars				2	1
Battery & Fuel tank to be in separate compartments					
Buoyancy, whether foam or bottles (Provide Certificate)					
Copy of COF & COC Certificate (Provide Certificate)					1
Red Flag				1	1
VHF Radio with Antenna MSI Number & SRC					

CATEGORY INDEX

- Category B** - Commercial and Pleasure Vessels - operating less than 40 nautical miles from shore.
- Category C** - Commercial and Pleasure Vessels - operating less than 15 nautical miles from shore.
- Category D** - Commercial and Pleasure Vessels - operating less than 5 nautical miles from shore.
(that are not passenger vessels - (more than 12 passengers)
- Category E** - Commercial and Pleasure Vessels - operating less than 1 nautical miles from shore.
(that are not passenger vessels - (more than 12 passengers)
- Category R** - Commercial and Pleasure Vessels - operating solely in sheltered waters.
(that are not passenger vessels - (more than 12 passengers)



PLUMBING & GALLEY

Vent Hose sold per meter

A1



Part No.
A44-P1606075 - 3"
A44-P1606100 - 4"

Perko Comb Fill / Vent

A2



Part No.
A44-1319G00BLK - Perko Comb Gas Fill / Vent
A44-1319G00WHT - Perko Comb Gas Fill / Vent
A44-1319W00WHT - Perko Comb Water Fill / Vent

Gas / Fill Vent

A3



Part No.
A44-0540G00CHR

Deck Fill and Tank Vent

A4

(Diameter: 1-1/2") AISI 316



Part No.
A44-008971

Deck Hose "Gas" 1-1/2"

A5



Part No.
A44-30101

Push-up Deck Fill

A6

(Diameter: 1-1/2") AISI 316



Part No.
A44-008925 - Gas

Locking Gas Fill

A7



Part No.
A44-0599G00CHR

Deck Fill Petrol

A8



Part No.
A44-80210-01PT - 1 - 1/2mm
A44-80202-PT - 38mm
A44-80204-PT - 38mm

Chrome Plated Thru-hull Connection B1



Part No.
A44-0350S05CHR

Plastic Thru-hull Connection B2



Part No.
A44-41542 - 3/4"
A44-41545 - 1/4"
A44-072618 - 18mm

Stainless Steel Thru-hull Connection B3



Part No.
A44-011034 - 3/4"

S/S Tank Vents B4



Part No.
A44-003770
A23-11504

Fuel Tank Vent Round Head B5
19mm Hose Size



Part No.
A44-003795

Gas Vent B6



Part No.
A44-80210
A44-80211

Locking Insert B7



Part No.
A44-0525DP0DIS

Bilge Pump B8



Part No.
A44-188432 - 500 GPH
A44-168462 - 1500 GPH
A44-18032-12 - 1100 GPH

Automatic Bilge Pump

C1



Part No.
 A44-18050 - 500 GPH
 A44-18051 - 700 GPH
 A44-18052 - 1500 GPH
 A44-18053 - 1800 GPH
 A44-18054 - 2000 GPH

Attwood - Tsunami Bilge Pump

C2



Part No.
 A44-4606EC-7 - 12V 500 GPH
 A44-4608EC-7 - 12V 800 GPH
 A44-4612EC-7 - 12V 1200 GPH

Attwood - Sahara Automatic Bilge Pump

C3



Part No.
 A44-4505EC-7 - 500 GPH
 A44-4507EC-7 - 750 GPH
 A44-4511EC-7 - 1100 GPH

Aerator Pump Kit

C4



Part No.
 A44-P1602306

Attwood - Tsunami Aerator Pump

C5



Part No.
 A44-4640EC-7 - 500 GPH
 A44-4650EC-7 - 800 GPH
 A44-4650EC-1 - 800 GPH

In-line Bilge Blowers 12V

C6



Part No.
 A44-P1610105 - C11601 3" In-line
 A44-P1627075 - C11603 4" In-line

C11601 Blower In-line @ 20

C7

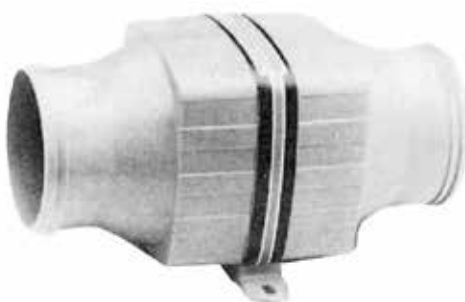

Part No.
 A44-11601- 3"
 A44-113120- WH - 4"

Turbo In-line Blower 12V 3"

C8



Part No.
 A44-13019-BK

Automatic Aerator Control

D1



Part No.
A44-AAC-1-DP

Aerator Spray Head

D2



Part No.
A44-AHVWD-90-DP

Bilge Pump Installation Kit

D3



Part No.
A44-C11843
A44-C11844

Auto Float Switch

D4



Part No.
A44-C11541

Aerator Intake Strainer

D5



Part No.
A44-AS-1-DP or A44-4323-1

Aerator Head Packaged

D6



Part No.
A44-4125-7

Thr-Hull W/Strainer 3/4"

D7



Part No.
A44-3886-1



BOATING HARDWARE

Attwood Flush Hatch

A1



Part No.
A46-2027-7

Flush Latch

A2



Part No.
A46-80264 - Flush Latch S/S 316 2" Diameter
A46-007931 - Flush Hatch Lift Latch

Flush Lock

A3



Part No.
A46-1091004BLK - Black
A46-1091004WHT - White

Surface Mount Lock and Latch

A4



Part No.
A46-1091DPIWHT

Perko Flush Pull

A5



Part No.
A46-931001BLK - Black
A46-1016000WHT - White

Compression Latch

A6



Part No.
A46-008349

Locking Lift Ring Surface Mount

A7



Part No.
A46-008381

Per Durable Type Fastener

A8



Part No.
A46-869000STS - Stud 100
A46-896000NKL - Button 100
A46-898000NKL - Socket 100

Clamshell Ventilator

SS 11/2" x 1 5/8"

B1



Part No.
A46-13520

Electric Hydraulic Trim N Tilt

B2



Part No.
A46-13001 - 130Hp and smaller with gauge
A46-13002 - 130Hp and smaller without gauge

Electric Hydraulic Trim N Tilt 35HP and Smaller

B3



Part No.
A46-52100 - Special Order Only

CMC TRSM Jack 2 Pieces MNL

B4



Part No.
A46-55012 - 5.5" Setback V6 and smaller

CMC Jack Plate 300HP and Smaller

B5



Part No.
A46-65302 - 5.5" Hydraulic W/O Gauge
A46-65012 - Manual 10" Setback

6' Set-back Manual Single

B6



Part No.
A46-JPZ-6-DP - Up to 300HP

Atlas Set-back Hydraulics 6"

B7



Part No.
A46-AHJ-6V-DP - 300HP up to 284kg

Atlas 4" Jack Plate 400Hp HD

B8



Part No.
A46-AHJ-4V-HD

Vertical Ext. 2.5" / 5"

C1

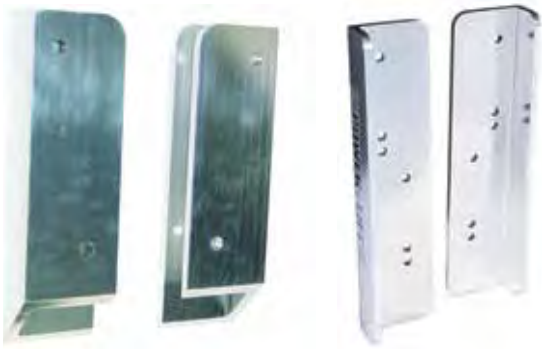

Part No.
A46-65213

Part No.
A46-50012

SB Extension 4"

C2



Part No.
64-891760A04

Fastener Kit SS Delux

C3



Part No.
A46-12152-3

BIMINI Top - White

C4

3 Arch Sombrero -
UV Resistant



Part No.
A46-O2903170 - 180 (L) x 170 (W) x 110cm (H)
A46-O2803200 - 200 (L) x 170 (W) x 140cm (H)

BIMINI Top - Navy Blue

C5

3 Arch Sombrero -
UV Resistant



Part No.
A46-O2903185 - 180 (L) x 180 (W) x 110cm (H)
A46-O2903200 - 200 (L) x 170 (W) x 140cm (H)

Over the top BIMINI

C6

Fits MTK Monster
Tower



NO IMAGE
AVAILABLE

Part No.
A46-MTK-BIM-1

Wake Tower Monster MT1

C7

Polished Tower



Part No.
A46-SOT100

Wake Tower Black MT1

C8

Black Tower



Part No.
A46-SOT101

Wake Board Anodized Monster MT2

D1



Part No.
A46-SOT200/201

MTK

Stunning good looks.

D2



Part No.
White - A46-MTK-XL
Black - A46-SOT407
Polished - A46-SOT405

MTK
Matte Black Stealth Edition

D3



Part No.
A46-SOT409

MTE

Polished and Anodized

D4



Part No.
A46-SOT301

Monster Wakeboard Rack

D5

Quick release for storage



Part No.
A46-WBRBA-2.5 - Chrome
A46-WBRBA-BK-2.5 - Black

Wakeboard/Surf Combo

D6

- Rubber bumpers and a bungee retaining strap
- Brushed and anodized aluminium



Part No.
A46-SWR-2.5

Swivel Wake/Surf

D7

- Rubber bumpers and a bungee retaining strap
- Brushed and anodized aluminium finish



Part No.
A46-SWRS-2.5

Water Ski Rack

D8

Features quick release for storage



Part No.
A46-WSR-2.5

Single Barrel Speakers

E1

These single Barrel Speakers use Polk DB652, Kicker KM6,5 or Wet Sounds XS650 speakers.



Part No.
A46-PLK-SG-BR-2.5 - Chrome

Polk DB652



Double Barrel Speakers

E2

These Double Barrel Speakers use Polk DB652, Kicker KM6,5 or Wet Sounds XS650 speakers.



Part No.
A46-PLK-DS-CR-2.5 - Chrome

Polk DB652



Single Barrel Speakers

E3

These single Barrel Speakers use Polk DB652, Kicker KM6,5 or Wet Sounds XS650 speakers.



Part No.
A46-KIK-SG-BK-2.5 - Black

Kicker KM6.6



Double Barrel Speakers

E4

These Double Barrel Speakers use Polk DB652, Kicker KM6,5 or Wet Sounds XS650 speakers.



Part No.
A46-KIK-DB-BK-2.5 - Black

Kicker KM6.5



Mirror Mount Quick Release

E5



Part No.
A46-MIR 2.5

XTP Mirror Mount

E6



Part No.
A46-XTP-MIR-212

Windshield Mount Mirror

E7



Part No.
A46-SKR011 - Mirror and mount

Four Light Bar

E8



Part No.
A46-LB-2.5 - Specifically for 2.5" diameter towers

Monster Tow Light Set (Pair)

F1



Part No.
A46-L5-25-2.5

Horn Single Trumpet

F2



Part No.
A46-15018

Folding Net Small

F3



Part No.
A46-12772-2 - Small
A46-12773-2 - Medium
A46-12774-2 - Large

Boat Cover

F4



Part No.
A46-O2222488 - XS
A46-O2223488 - S
A46-O2224579 - M
A46-O2226610 - L
A46-O2229650 - XL
A46-O2238710 - XXL

Full Engine Cover

F5



Part No.
A46-O2225075 - S
A46-O2215087 - M
A46-O2221125 - L



Unit 3A & 3B City Deep Industrial Park,
36 Fortune Street, City Deep,
Johannesburg 2049
Tel (011) 878-2600
VAT NO:

ORDER FORM

SHIP TO:

NAME: _____

COMPANY: _____

ADDRESS: _____

POSTAL CODE: _____

TEL: _____

DATE: _____

Stock Code:	Description	Quantity	Unit Price	Total
Comments:	Sub Total			
	Vat			
	Shipping			
	Total			



ANCHORS

Grapnels

A1



Part No.

A48-N1030031
 A48-N1025023 - 2,3kg
 A48-N1025055 - 5,5kg
 A48-N1020015 - Folding Grapnel 1,4kg
 A48-N1020035 - Folding Grapnel 3,5kg

Galvanized Folding Anchor

A2



Part No.

A48-020200 - 0,7kg
 A48-020201 - 1,5kg
 A48-020202 - 2,5kg
 A48-020203 - 3,2kg
 A48-020204 - 4kg
 A48-020206 - 6kg
 A48-020208 - 8kg

Danforth Anchor

A3



Part No.

A48-020603 - 3kg
 A48-020605 - 5kg
 A48-020608 - 8kg
 A48-N1200004 - 4,0kg
 A48-N1200006 - 6kg
 A48-N1200008 - 8kg
 A48-N1200010 - 10kg

Drouge Anchor "Squidy"

A4



Part No.

A48-N1306053 - 60"
 A48-N1310110 - 70"
 A48-N1308070 - 80"

Anchor

A5



Part No.

A48-N1315025 - Small Floating

Anchor Line on Spool

A6



Part No.

A48-18010-50 - 10mm x 50mm
 A48-18010-100 - 10mm x 100mm

Polyester Twisted Anchor Rope

A7

10mm x 200m



Part No.

A48-18010



WATERSPORTS

Neoprene Red PFD

A1



Part No.

- A50-H011-2XL-RED
- A50-H011-L-RED - L
- A50-H011-M-RED - M
- A50-H011-S-RED - S
- A50-H011-XL-RED - XL
- A50-H011-XS-RED - XS
- A50-H011-Y-RED - Youth

Neoprene Blue PFD

A2



Part No.

- A50-H011-2XL-BLUE - 2XL
- A50-H011-L-BLUE - L
- A50-H011-M-BLUE - M
- A50-H011-S-BLUE - S
- A50-H011-XL-BLUE - XL
- A50-H011-XS-BLUE - XS
- A50-H011-Y-BLUE - Youth

Neoprene Green PFD

A3



Part No.

- A50-H011-2XL-GREEN - 2XL
- A50-H011-L-GREEN - L
- A50-H011-M-GREEN - M
- A50-H011-S-GREEN - S
- A50-H011-XL-GREEN - XL
- A50-H011-XS-GREEN - XS
- A50-H011-Y-GREEN - Youth

Neoprene Yellow PFD

A4



Part No.

- A50-H011-2XL-YELLOW - 2XL
- A50-H011-L-YELLOW - L
- A50-H011-M-YELLOW - M
- A50-H011-S-YELLOW - S
- A50-H011-XL-YELLOW - XL
- A50-H011-XS-YELLOW - XS
- A50-H011-Y-YELLOW - Youth

Ladies Neoprene Pink PFD

A5



Part No.

- A50-H011L-L-PINK - L
- A50-H011L-M-PINK - M
- A50-H011L-S-PINK - S
- A50-H011L-Y-PINK - Youth

Ladies Neoprene Turquoise PFD

A6



Part No.

- A50-H011L-L-TURQUOISE - L
- A50-H011L-M-TURQUOISE - M
- A50-H011L-S-TURQUOISE - S
- A50-H011L-Y-TURQUOISE - Youth

Infant/Child Neoprene Lifejackets

A7



Part No.

- A50-H0131 - Infant
- A50-H013C - Child

4 Buckle Nylon Red PFD

A8



Part No.

- A50-N001-4XL-RED - 4XL
- A50-N001-3XL-RED - 3XL
- A50-N001-2XL-RED - 2XL
- A50-N001-XL-RED - XL
- A50-N001-L-RED - L
- A50-N001-M-RED - M
- A50-N001-S-RED - S
- A50-N001-XS-RED - XS

4 Buckle Nylon Green PFD B1



Part No.
 A50-N001-4XL-GREEN - 4XL
 A50-N001-3XL-GREEN - 3XL
 A50-N001-2XL-GREEN - 2XL
 A50-N001-XL-GREEN - XL
 A50-N001-L-GREEN - L
 A50-N001-M-GREEN - M
 A50-N001-S-GREEN - S
 A50-N001-XS-GREEN - XS

4 Buckle Nylon Yellow PFD B2



Part No.
 A50-N001-4XL-YELLOW - 4XL
 A50-N001-3XL-YELLOW - 3XL
 A50-N001-2XL-YELLOW - 2XL
 A50-N001-XL-YELLOW - XL
 A50-N001-L-YELLOW - L
 A50-N001-M-YELLOW - M
 A50-N001-S-YELLOW - S
 A50-N001-XS-YELLOW - XS

4 Buckle Nylon Pink PFD B3



Part No.
 A50-N001-L-PINK - L
 A50-N001-M-PINK - M
 A50-N001-S-PINK - S
 A50-N001-XS-PINK - XS

Youth Nylon Lifejacket Blue B4



Part No.
 A50-N0037-BLUE
 A50-N0037-GREEN
 A50-N0037-RED
 A50-N0037-PINK
 A50-N0037-YELLOW

Nylon Lifejacket B5



Part No.
 A50-N007-L - L
 A50-N007-M - M
 A50-N007-S - S
 A50-N007-XL - XL

Horse Collar Lifejacket B6



Part No.
 A50-N006-S/M
 A50-N006-L/XL

Baby/Child/Toddler/Youth Nylon Lifejacket B7



Part No.
 A50-N007Y-B - Baby
 A50-N007Y-C - Child
 A50-N007Y-T - Toddler
 A50-N007Y-Y - Youth



Airhead EZ Ski

C1

The EZ Ski is a revolutionary 1 Rider inflatable water ski hybrid - great for teaching youngster to ski, with a weight capacity of 30kgs.



Part No.
A50-AHEZ-100C

Airhead Big EZ Ski

C2

The EZ Ski is a revolutionary 1 Rider inflatable water ski hybrid - great for teaching older children to ski, with a weight capacity of 54kgs.



Part No.
A50-AHEZ-200C

Airhead Outrigger

C3

The concave bottom makes for one wild ride!
The tube of choice for choppy water as it rides on its rails.



Part No.
A50-AHOV-3C

Airhead Hot Shot

C4

Come on Hot Shot show us what you've got! Designed for one adult or 2 small children.



Part No.
A50-AHHS-12C

Airhead Slide

C5

1 Rider triangular tube - great for tricks.



Part No.
A50-AHSL-12C

Airhead Rebel Tube-Kit

C6

ALL-IN-ONE - Tube, Rope and Pump. Rebel is a 1 Rider deck tube.



Part No.
A50-AHRE-12C

Airhead Rip 1

C7

Designed for 1 rider, with fin action steering and new pivot action tow point.



Part No.
A50-AHRI-22

Airhead Strike

C8

Fully covered deck tube!



Part No.
A50-AHST-23

Airhead Mach 1

D1

Mach 1 provides a wild but stable ride for all ages including young children, teens and adults.



Part No.
A50-AHM1-1

Airhead Mach 2

D2

Budget minded double rider cockpit towable tube. Cockpit tubes provide a safe and comfortable seat, which is recommended for timid and young riders.



Part No.
A50-AHM2-2C

Airhead Blast

D3

You'll have a real blast on this 1 rider round towable with great eye-catching graphics.



Part No.
A50-AHBL-12C

Airhead Turboblast

D4

Turbo Blast is not only a head turner, it is one hot riding tube!



Part No.
A50-AHTB-12

Airhead Livewire 2 Rider

D5

With a variety of different riding options, AIRHEAD LIVE WIRE comes alive with energy on the water! Featuring dual tow points, either ride sitting down or in the opposite direction kneeling chariot style.



Part No.
A50-AHLW-2C

Airhead Livewire 3 Rider

D6

With a variety of different riding options, AIRHEAD LIVE WIRE comes alive with energy on the water! Featuring dual tow points, either ride sitting down or in the opposite direction kneeling chariot style.



Part No.
A50-AHLW-3C

Airhead Griffin 2 (2 Rider)

D7

Take flight on our newest 2 rider winged tube! Riders will roll up on the edges through turns and with shifts in weight. The wings also make them a joy to tow, as they slide effortlessly across wakes. Boarding straps in the back to make it easy to climb on board from the water.



Part No.
A50-AHGR-02C

Airhead Griffin 3 (3 Rider)

D8

Take flight on our newest 3 rider winged tube! Riders will roll up on the edges through turns and with shifts in weight. The wings also make them a joy to tow, as they slide effortlessly across wakes. Boarding straps in the back to make it easy to climb on board from the water.



Part No.
A50-AHGR-03C

AIRHEAD

Airhead Viper 1

VIPER inflatable tubes are perfect for young children who need a more secure ride or are new to water sports.



E1

Part No.
A50-AHV1-f.

Airhead Viper 2 Rider

Provides a stable ride and are especially popular with young children.



E2

Part No.
A50-AHV1-F2

Airhead Viper 3 Rider

Provides a stable ride and are especially popular with young children.



E3

Part No.
A50-AHV1-F3C

Airhead Disc-Go

DISC-GO is a real crowd pleaser with a fast learning curve. First time riders will be carving turns, riding backwards and doing 360s and even 720s in no time! This is the board that pleases like no other! DISC-GO is a huge polyurethane foam injected roto-molded disc with a rounded bottom.



E4

Part No.
A50-AHDG-01

Airhead Slice

Designed for 1 or 2 riders.



E5

Part No.
A50-AHSL-4WC

Airhead Super Slice

High performance 3 rider low profile deck tube, with tapered profile for easy boarding from the water.



E6

Part No.
A50-AHSSL-1C

Airhead Mega Slice

Suitable for 1 - 4 riders Tapered profile, thick in the front and thin at the back.



E7

Part No.
A50-AHSSL-4C

Airhead Slash II

Designed for 1 or 2 riders, with fin action steering and new pivot action tow point.



E8

Part No.
A50-AHSL-32C

Airhead Transformer 2

F1

AIRHEAD Transformer is 2 tubes in one! It transforms from a deck tube to a cockpit tube in seconds!



Part No.
A50-AHTF-2

Airhead Transformer 3

F2

This is 3 tubes in one. Designed for 1 - 3 riders, ride it deck-deck-deck, cockpit-deck-cockpit or cockpit-deck-deck



Part No.
A50-AHTF-3

Airhead Transformer 4

F3

AIRHEAD Transformer 4 is 4 tubes in 1, providing fun to 2, 3, 4, 5 or 6 riders at once! It's a comfortable 4 rider round "sit in" towable, a 2 rider deck style towable, a 3 rider deck style towable and a great "over the transom" lounge!



Part No.
A50-AHTF-4C

Airhead Revolution

F4

Deluxe 2 Rider Spinning towable.



Part No.
A50-AHRE-2

Airhead G-Force 2

F5

Up to 2 thrill-seekers. Defy centrifugal force with the G-Force's topside stabilizer fins.



Part No.
A50-AHGF-2C

Airhead G-Force 3

F6

Up to 3 thrill-seekers. Defy centrifugal force with the G-Force's topside stabilizer fins.



Part No.
A50-AHGF-3C

Airhead Wakesurf 2

F7

Doubles as a Kayak! Riders ride inline, like an on the water bobsled on AIRHEAD's unique Wake Surf towables.



Part No.
A50-AHWS-2

Airhead Wakesurf 3

F8

Doubles as a Kayak! Riders ride inline, like an on the water bobsled on AIRHEAD's unique Wake Surf towables.



Part No.
A50-AHWS-3

Airhead Hot Dog

G1

Designed to carry 1 – 3 riders – you'll have a good time and some real fun on this water sausage.



Part No.
A50-HD-3C

Airhead Jumbo Dog

G2

This bigger version is designed to carry 1 - 5 riders.



Part No.
A50-HD-5C

Airhead Double Dog

G3

Designed for 2 riders – climb on, hang on and have some serious fun.



Part No.
A50-HD-2C

Airhead Quad Dog (4 Rider)

G4

You can now enjoy a tandem ride with more stability on this "water sausage". QUAD DOG has deluxe nylon-wrapped handles with neoprene knuckle guards and four neoprene seat pads for comfort and to help you stay on top.



Part No.
A50-HD-4C

Airhead Riptide 2 (2 Rider)

G5

RIPTIDES feature comfortable seat pads and foam-filled tubular webbing handles with neoprene knuckle guards for firm and comfortable handholds. Two patented Speed Safety Valves provide the ultimate in inflation and deflation convenience.



Part No.
A50-AHRT-12C

Airhead Riptide 3 (3 Rider)

G6

RIPTIDES feature comfortable seat pads and foam-filled tubular webbing handles with neoprene knuckle guards for firm and comfortable handholds. Two patented Speed Safety Valves provide the ultimate in inflation and deflation convenience.



Part No.
A50-AHRT-13C

Airhead Switchback

G7

Two riders sit in front with a comfortable inflatable backrest and side panels to keep them in place. The other 2 riders kneel behind them, riding chariot style. It's a totally different sensation riding in front or back, so it's like 2 tubes in 1, consequently the name Switchback!



Part No.
11-A50-AHSB-4C

Airhead Fusion 2

G8

Designed to carry 1-5 riders - you'll have a good time and some real fun on this water sausage.



Part No.
A50-AHFN-12

Throne 1 (Single Rider) H1

THRONE SERIES
Popular, roomy and the perhaps the most comfortable towables ever. Feel like a king or queen sitting on your THRONE



Part No.
A50-AHTN-1C

Throne 2 (2 Rider) H2

THRONE SERIES
Popular, roomy and the perhaps the most comfortable towables ever. Feel like a king or queen sitting on your THRONE



Part No.
A50-AHTN-2C

Throne 3 (3 Rider) H3

Popular, roomy and the perhaps the most comfortable towables ever. Feel like a king or queen sitting on your THRONE



Part No.
A50-AHTN-3C

Airhead Shockwave (2 Rider) H4



Part No.
A50-AHSH-2C

Airhead Shockwave (3 Rider) H5



Part No.
A50-AHSH-3C

Airhead Mega Rock Star H6

A real blast for up to 6 riders. There are many ways to ride and the rocking motion ands lots of fun!



Part No.
A50-AHRS-6

Airhead Tremor H7

Shake things up with Tremor. A multi-level circular ride for up to 4 children or adults.



Part No.
A50-AHTM-4

Airhead Big Shot H8

This stunning 4 rider towable glides across wakes with the greatest of ease.



Part No.
A50-BS-1C

Airhead Bob

11

The tow rope with an inflatable buoy in the middle to boost the performance of your towable.



Part No.
A50-AHBOB-1C

Airhead Cool Island

12



Part No.
A50-AHC1-1C

Airhead Skurfer

13



Part No.
A50-AHEZ-300C

Airhead Zooka double Shot

14



Part No.
A50-A2-18

Airhead Aqua Zooka double Shot

15



Part No.
A50-A2-24DS

Airhead Aqua Zooka 18



Part No.
A50-A2-18DS

Airhead Gang Plank

16



Part No.
A50-AHGP-6C

Airhead Delux Kayak Paddle

17

Breaks down into 2 sections for convenient stowing. The lightweight and durable aluminium shaft has drip rings and foam hand grips for comfort and to ensure that the paddle will float if dropped. The large ABS blades are curved for greater paddling efficiency.



Part No.
A50-AHTK-P2

Airhead Stand Up Paddle Board Paddle

AIRHEAD's lightweight SUP paddle is truly a one-size-fits-all paddle. The length is easily adjustable from 160 to 210 cm.



Part No.
A50-AHSUP-P1

Airhead Na Pali Stand Up Paddle Board

18

When you're out on the water, Na Pali is rigid and will perform like a fibreglass board. Feel like sitting down? Install the seat in seconds and paddle kayak style.



Part No.
A50-AHSUP-1
A50-AHSUP-1 Seat Pump

Airhead Wakeshaker Kneeboard

J1

WAKE SHAKER makes knee boarding easier and more fun to ride! You'll love the easy rail-to-rail transitions, consistent arc through turns and effortless spins! Wake Shaker is great for all riding levels.



Part No.
A50-AHKB-3

Airhead SS Stand Up Paddle Board

J2

SS stands for "Super Stable", and that's just what this very special inflatable SUP is. Beginners, intermediates and larger riders love the SS's unparalleled stability.



Part No.
A50-AHSUP-2

Airhead Banzai Wakesurfer

J3

BANZAI is the Cadillac of wakesurf boards. Its classic shape is easy to get up on and forgiving, perfect for beginners, intermediates, smaller wakes and bigger people.



Part No.
A50-AHWS-F01

Airhead Pfish Skim Wakesurfer

J4

PFISH is a really fun wakesurf board for any rider, beginner to advanced. The full shape and fish tail setup is forgiving and gives beginners an easy platform to learn the glide. Advanced riders will find it a nice stable board that shreds and cops air with ease. PFISH has 2 fins and is for riders up to 79kg.



Part No.
A50-AHWS-F02

Airhead S-1300 Combo Skis

J5



Part No.
A50-AHS-1300

Airhead S-1400 Wide Body Skis

J6



Part No.
A50-AHS-1400

Airhead Wide Body Ski

J7



Part No.
A50-AHS-900

Airhead Wide Trainer Ski

J8



Part No.
A50-AHST-110

Airhead 12V Air Pump

K1

This high-volume 12 volt portable air pump inflates and deflates towables, boats, pools, mattresses and beach toys quickly. The universal valve fittings fit many popular valves including Boston valves and stem valves. For added convenience, the cigarette lighter plug is equipped with a 10 ft. long power cord.



Part No.
A50-AHP-12H

Airhead Air Pig 12V Pump

K2

Four adapters for the most popular air valves are included.



Part No.
A50-AHP-12AP

Airhead Ladder Rack

K3



Part No.
A50-LR-1

Airhead Bling Tube Ropes

K4



Part No.
A50-AHTR-12BL - 2,375lb. Tensile Strength, for up to 2 Rider Towables
A50-AHTR-14BL - 4,100lb. Tensile Strength, for up to 4 Rider Towables
A50-AHTR-16BL - 6,000lb. Tensile Strength, for up to 6 Rider Towables

Airhead 2 Section 2 Rider Tube Tow Rope

K5



Part No.
A50-AHTR-22

Airhead 4 Rider Tube Rope

K6



Part No.
A50-AHTR-42

Airhead Delux 4, 150lb, 4 Rider Tube Tow Rope

K7



Part No.
A50-AHTR-4000

Airhead Bungee Tube Tow Rope 50ft

K8



Part No.
A50-AHTRB-50C

Airhead Bling Spectra Wakeboard Rope L1



Part No.
A50-AHWR-11BL
A50-AHWR-12BL
A50-AHWR-13BL

Airhead Ski-Rope 1 Section L2



Part No.
A50-AHSR-1EVA

Airhead Promotional Water Ski-Rope L3



Part No.
A50-AHSR-1

Airhead 8 Section Radius Handle Ski-Rope L4



Part No.
A50-AHSR-8

Airhead Performance Radius Handle Ski-Rope L5



Part No.
A50-AHSR-3

Airhead 1 Section Ski-Rope L6



Part No.
A50-AHSR-5

Airhead Ski-Rope Deep V Slalom L7



Part No.
A50-AHSR-2

Airhead Ski-Rope 4 Section L8



Part No.
A50-AHSR-4

AIRHEAD**Airhead Ski-Rope 75ft 1 Sec**

M1

Part No.
A50-AHSR-75**Airhead WS Rope Eva Handle**

M2

Part No.
A50-AHSR-9**Airhead W/B Rope Phat Grip**

M3

Part No.
A50-AHWR-1**Airhead W/B Rope 15" Eva**

M4

Part No.
A50-AHWR-3**Airhead Spectra Fusion Wakeboard Rope**

M5

Part No.
A50-AHWR-5**Airhead A/H Spectra Thermal Rope**

M6

Part No.
A50-AHWR-4**Airhead Dyna Core Wake Rope**

M7

Part No.
A50-AHWR-6**Airhead Dyna W/B rope**

M8

Part No.
A50-AHWR-8

Airhead Wakesurf Rope

N1



Part No.
A50-AHWS-R01

Airhead Tube Rope

N2



Part No.
A50-AHTR-6000

Airhead Tow Harness

N3



Part No.
A50-AHTH-1
A50-AHTH-31

Airhead Heavy Duty Tow Harness

N4



Part No.
A50-AHTH-2
A50-AHTH-8HD

Airhead Tow Harness Self Centre

N5



Part No.
A50-AHTH-3
A50-AHTH-9 - 14ft

Airhead Kwik Connect

N6



Part No.
A50-AHKC-1

Airhead Bungee Dock Line

N7



Part No.
A50-AHDL-4
A50-AHDL-5
A50-AHDL-6

Airhead Tubekeeper

N8



Part No.
TB-101

Airhead Tow Demon

01



Part No.
 A50-AHTH-4 - 8" Rope
 A50-AHTH-5 - 12" Rope
 A50-AHTH-6 - 8" Cable
 A50-AHTH-7 - 12" Cable

Airhead Airpressure Gauge

02



Part No.
 A50-AHPG-1

Airhead Line Winder

03



Part No.
 A50-AHLW-1

Airhead 20" Diameter Buoys

04



Part No.
 A50-B-20R - Red
 A50-B-20Y - Yellow

Airhead Boston Valve, 2 Pack

05



Part No.
 A50-AHBV-2

Airhead Multi-Valve

06



Part No.
 A50-AHMY-1

Airhead Float 5" x 3"

07



Part No.
 A50-F-5R - Red
 A50-F-5Y - Yellow

Airhead Vinyl Repair Kit

08



Part No.
 A50-AHRK-1

Airhead Wrap it-up

P1



Part No.
A50-AH-WR-12100

**Airhead Wrap it-up
(3Pk) Black**

P2



Part No.
A50-AH-WR-1123BK

Airhead Air Daddy

P3



Part No.
A50-AHAD-1

Popa Wheelie

Q1

Mild or Wild? SPORTSSTUFF's Popa Wheelies deliver both! Connect the Kwik Connect to the Mild Tow Point (front) for a conventional tube ride. Connect it to the Wild Town Point (bottom) for a wild ride.



Part No.
A50-53-1922C

Big Betty

Q2

The new Big Betty series of towables is an off shoot from our popular Mable series with the added feature of dividers between riders. It will continue to impress you with a variety of different riding options.



Part No.
A50-53-3002C

Super Betty

Q3

All three sizes come equipped with comfy EVA foam seating pads. A multitude of foam filled webbing handles with knuckle guards enable lots of different riding positions. Air cushioned sidewalls helps keep you on board.



Part No.
A50-53-3003C

Great Big Betty

Q4

The patented Speed Safety Valve and Kwik Connect will save you time. The Bettys feature a heavy-duty K80 PVC bladder and double stitched full nylon cover with self bailing drain vents. They also make the perfect deluxe lounge at any pool, beach, lake or river.



Part No.
A50-53-3004C

Big Mable

Q5

The classic Mable towables will continue to impress you with a variety of different riding options.



Part No.
1A50-53-2213C

Super Mable

Q6

Featuring dual tow points, you can go for a wild ride utilizing the comfy backrest or town them in opposite directions for a chariot style blast you'll never forget. All three sizes comes equipped with comfy EVA foam seating pods.



Part No.
A50-53-2223C

Great Big Mable

Q7

The addition of air cushioned side walls will keep you on board while the redesigned backrest and custom graphics make this uniquely shaped towable dressed to impress. The patented Speed Safety Valve and Kwik connect tow point will save you time.



Part No.
A50-53-2218C

Grandstand 2

Q8

Stand up and shout on the amazing Grandstands! These one-of-a-kind towables feature a unique nose design for effortless towing and a Kwik Connect tow point to get your tow rope hooked up in no time. Speed Safety Valves deliver the fastest inflation possible.



Part No.
A50-53-1860C

Poparazzi 2

R1

The Poparazzi has a unique, high winged shape with rocker bottom that allows you to carve into the wake and glide across the water's surface with minimal drag. With a turn of the boat, inside riders will teeter deep into the wake while the other riders will rise high above it!



Part No.
A50-53-1752C

Poparazzi 3

R2

Multiple EVA foam body pads allow riders to comfortably perform every riding position imaginable. The unique High Rise Tower equipped with multiple double webbing foam handles with knuckle guards allow standing or kneeling on the back deck.



Part No.
A50-53-1750C

Half Pipe Rampage

R3

Enjoy the amazing Half Pipe series sitting, kneeling, lying down, or even sideways! The high angled sides gives this tube sensational action while maintaining a great deal of stability.



Part No.
A50-53-2155C

Half Pipe Frantic

R4

Featuring a heavy-duty full nylon cover, EVA foam body pads for each rider. There are multiple flat foam boarding handles for each rider as well as double webbing foam handles with knuckle guards.



Part No.
A50-53-2160C

Bandwagon 2+2

R5

The one-of-a-kind Bandwagon features a dragless nose design for effortless towing that eliminates nose diving at startup. The innovative seating arrangement allows you to sit forward, backward, kneeling or lying down for the style of ride you're craving.



Part No.
A50-53-1620C

Chariot Warbird 2

R6

The Chariot Warbirds' wide wingspans allow you to challenge even the toughest wake, while remaining one of the most stable rides on the water.



Part No.
A50-53-1780C

Chariot Warbird 3

R7

By simply switching the innovative dual tow point the Chariot Warbirds can be towed in the opposite direction, transforming them into a completely different ride.



Part No.
A50-53-1790C

Stunt Flyer

R8

The classic Flyer Decktube has been redesigned with a hot new look! They come in equipped with two large EVA foam body parts to protect your knees and elbows.



Part No.
A50-53-1651C

Zip Ski

Challenge any wake with the smooth riding Zip Sky! This popular MY-T tube has a fast and easy aluminium Kwik Connect tow system and Speed Valve so you can inflate and deflate in a hurry and concentrate on having fun.



S1

Part No.
A50-53-1313C

VIP Sportstube

The classic VIP Sportstube features the patented Speed Safety Valve for fast inflation and deflation, heavy-duty moulded PVC handles so you can get a grip, and heavy-duty moulded tow system.



S2

Part No.
A50-53-1116C

Crazy 8

Grab a friend and prepare for a wild & crazy tubing experience on the Crazy 8 for tow riders. Dual tow points allow sitting in-line or side-by-side for 2 totally different riding experiences. The unique figure-eight design features a heavy-duty double-stitched partial nylon cover and heavy-duty K80 PVC bladder that's built to last.



S3

Part No.
A50-53-1450C



QUICKSILVER

HyDrive



MotorGuide



RITCHIE
NAVIGATION

VARTA



OPTIMA
BATTERIES
THE ULTIMATE POWER SOURCE™



steerflex

maxflex



KICKER

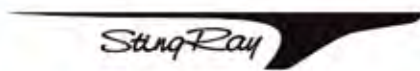

AIRHEAD



OMC



BOSS
marine





Gauteng - Unit 3A & 3B City Deep Industrial Park,
36 Fortune Street, City Deep
Tel (011) 878-2600

www.rutherfordmarine.co.za